An Enquiry into the Variation of Angles Observed in Crystals; Especially of Potassium-Alum and Ammonium-Alum

Henry A. Miers

Phil. Trans. R. Soc. Lond. A 1904 **202**, 459-523

doi: 10.1098/rsta.1904.0011

Email alerting service

Receive free email alerts when new articles cite this article - sign up in the box at the top right-hand corner of the article or click [here](#)

To subscribe to *Phil. Trans. R. Soc. Lond. A* go to: <http://rsta.royalsocietypublishing.org/subscriptions>

XI. *An Enquiry into the Variation of Angles observed in Crystals; especially of Potassium-alum and Ammonium-alum.*

By HENRY A. MIERS, *D.Sc., M.A., F.R.S., V.P.G.S., V.P.C.S., Waynflete Professor of Mineralogy in the University of Oxford.*

Received March 10,—Read March 26, 1903.

[PLATE 13.]

CONTENTS.

PART I.—THE OCTAHEDRON ANGLE OF ALUM AND ITS VICINAL PLANES.		Page
1. The variations of angle previously observed		460
2. Object of the present investigation		463
3. The goniometer.		464
4. Purposes for which the goniometer can be used		466
(A.) Etching of calcite with HCl		467
(B.) Parallel growth of NaNO ₃ with calcite		468
5. The octahedron angle of potash-alum		469
6. The nature of the vicinal faces on potash-alum and ammonia-alum		475
7. The vicinal faces on sodium chlorate, zinc sulphate, and magnesium sulphate		483
8. The effect on alum of diluting the solution		487
9. Some possible causes of the variations		489
PART II.—THE CONCENTRATION OF THE SOLUTION IN CONTACT WITH A GROWING CRYSTAL.		
A. Preliminary experiments		492
B. The refractive indices of supersaturated solutions		496
(1.) Potash-alum		497
(2.) Tartaric acid		501
(3.) Sodium chlorate		504
(4.) Sodium nitrate		507
C. The refractive index and concentration of the solution in contact with a growing crystal		510
(1.) Potash-alum		511
Specific gravity of solution in contact with a growing crystal of potash-alum		513
(2.) Sodium chlorate		513
(3.) Sodium nitrate		515
PART III.—THE ACTION OF THE CONCENTRATION STREAMS (CRYSTALLISATION IN MOTION).		
Interpretation of the foregoing results. A possible cause for the variation of angle in alum and other crystals		516
Experiments upon potassium-alum crystallising in an agitated solution		518
VOL. CCII.—A 356.	3 N 2	15.12.03

PART I.

(1.) THE VARIATIONS OF ANGLE PREVIOUSLY OBSERVED.

ALL who have been practically engaged in goniometric measurements are well aware that in crystals of one and the same substance small variations of angle are usually encountered even when the crystals are taken at the same time from the same solution. The differences are sometimes so small that they are only appreciable by a goniometer which will read accurately to 1 minute or less, and very often the crystal faces themselves are too irregular or too imperfect to yield sharp images of the collimator slit such that they can be adjusted within, say, half a minute.

But even if account be taken only of those faces which are truly plane and yield a perfectly sharp reflection of the collimator slit, the individual variations may amount to 5 or 10 minutes, and the measurements of the same angle made upon, say, 20 good crystals of the same substance, may differ to this extent. I have studied* an example from the mineral kingdom in the case of the very beautifully crystallised Proustite, where the angle between perfectly smooth and plane rhombohedron faces varied between $42^{\circ} 39' 50''$ and $42^{\circ} 48' 27''$, *even upon the same crystal*.

It is customary to eliminate these variations, as well as errors of reading due to the imperfection of the faces, by measuring a considerable number of crystals and taking the mean of corresponding measurements. This process appears to lead to very satisfactory results, for angles may sometimes be obtained which are consistent even within half a minute of arc ; that is to say, the lengths and mutual inclinations of the crystal axes having been calculated from some of these angles, the remaining angles are calculated on the assumption that they belong to planes whose intercepts are certain rational sub-multiples of the axes, and they are then found to agree very closely with the means of the observations.

Two assumptions are here made : (1) that the individual variations are just as likely to give angles which are too large as angles which are too small, and (2) that the faces do obey the law of *simple* rational indices.

Even when the calculations are made by the method of least squares, these assumptions still underlie the process.

The small individual variations are, in fact, regarded as irregular and of secondary importance, and are practically ignored ; if they be thus left out of account, it cannot be denied that within narrow limits the angles of most crystals do approximate very closely to those required by the law of simple rational indices. Occasionally, however, the deviation is too great to be treated in this way, and the direction of the face can

* 'Mineralogical Magazine,' vol. 8, 1888, p. 49.

no longer be expressed by simple rational indices, but only by very high numbers. Cubes of fluor, for example, will often yield no reflections corresponding to the true faces of a cube, and, therefore, do not possess angles of 90° ; but each apparent cube face really consists of a very flat pyramid whose adjacent planes are inclined to each other at the angle $2^\circ 31\frac{3}{4}'$. These faces would intersect the axes of the cube in the ratio 1 : 32, and belong to the form (32.1.0).

Such "vicinal faces" are encountered upon crystals of most substances; sometimes they are produced by the solvent action of the mother-liquor; but they may certainly also appear during the growth of the crystal when it is not being redissolved. The vicinal faces themselves are sometimes as perfectly plane and smooth as any on the crystals.

In the case of fluor, the presence of the group of four such planes in place of the cube face shows that they are not merely due to the distortion of a cube face, but belong to a different form. But even when a face with high indices occurs upon a crystal as a single isolated plane, it is generally regarded as a vicinal face and either as due to the etching action of a solvent, or as replacing a face with simpler indices owing to the operation of some unknown cause.

Whether the vicinal faces really obey the law of rational indices at all is not certain. Planes to which it is necessary to attribute high indices are usually called "vicinal," and are regarded as something different from ordinary faces; many careful measurements of individual vicinal planes have been made in order to determine their indices, whereas it is the custom to eliminate variations in the angle between what appear to be faces of simple forms. Sometimes, however, these variations are so large, even in the case of what appear to be quite simple forms, that they can scarcely be ignored in this manner.

In most of the crystalline systems the theoretical angles of the crystal are not known, but have to be calculated from some of the observed angles, which may be themselves liable to these variations, so that it is difficult to say whether the variations are really irregular. But in the cubic system, by virtue of its symmetry, the angles are known absolutely, and it is possible to compare the measured angles with the theoretical values. Crystals belonging to the cubic system appear, however, to be liable to the same variations of angle with those of other systems, and also exhibit vicinal faces.

Now the whole value of the law of rational indices, which is the foundation-stone of crystallography, rests upon the permanence of angle. The faces of an octahedron belonging to the cubic system are inclined to each other at $70^\circ 31' 44''$; and, similarly, the angle of the form (112), of which any face cuts two of the axes of the octahedron at their extremities and bisects the third, is $38^\circ 56' 33''$. If the octahedron and icositetrahedron faces do not make these angles, respectively, then the law of rational indices is only a first approximation, and there is some disturbing influence which has yet to be investigated.

It must be observed that two interpretations are possible :—

- (1) That the faces really have simple indices, but are liable to irregular variations ;
- (2) That they have not really simple indices, but are vicinal faces.

Thus an octahedron whose angle is found to be, not $70^{\circ} 31' 44''$, but $69^{\circ} 41'$, would on the first interpretation be an octahedron of which one or more faces are distorted from their true position by some unexplained cause ; on the second interpretation they would not be faces of the octahedron at all, but a vicinal form having the indices (65.65.64), of which each face is inclined at 25 minutes to the octahedron face with which it nearly coincides.

In the simple case here contemplated it ought to be quite easy to distinguish between the two interpretations, for the form (65.65.64) consists of, not 8, but 24 faces, and each face of the apparent octahedron should yield, when measured on the goniometer, not one image of the collimator slit, but three images, due to three facets, each deviating by 25 minutes from the true octahedron face.

Very careful observations upon the angles of cubic crystals have been made by several investigators. PFAFF published in 1878* an investigation on the variations of crystal angles, in which he found that angles which were known from the symmetry of the system might differ by 30 minutes from the theoretical value, or might agree with it to within 1 minute. He came to the conclusion that the variations of angle are related to the existence of optical anomalies, and that in the cubic system those crystals which are birefringent exhibit these variations, whereas those which are isotropic do not. A natural deduction would be that the observed variations are the result of strain.

Some years later this problem was proposed for a prize essay by the Philosophical Faculty of the University of Marburg, and the inquiry was limited to crystals belonging to the cubic system ; candidates were directed to measure isotropic and birefringent crystals of the same substance with the view of ascertaining whether any such relationship exists.

The prize essay, by R. BRAUNS, was published in 1887.† He carefully measured octahedra of lead nitrate, of spinel, and of ammonia-alumina-alum, choosing both isotropic and birefringent crystals, and came to the conclusion that there is no difference between the angles of isotropic and birefringent cubic crystals. Of 120 measured angles (on 15 crystals) 86 gave a deviation of 5 minutes or less, and 63 a deviation of more than 10 minutes. The largest deviation from the theoretical value was $19' 20''$; the largest deviation for the angle as measured between faces which gave very perfect images was $13' 20''$, in the case of a crystal of lead nitrate.

BRAUNS further made an interesting suggestion regarding the cause of these

* 'Sitzungsber. d. Physik. Med. Soc. zu Erlangen,' Heft 10, p. 59.

† 'Neues Jahrbuch,' 1887, (1), p. 138.

deviations; the crystals of lead nitrate showed a certain regularity in the angles; they had all grown lying on an octahedron face ($\overline{111}$); now if the obtuse angles made by the upper face (111) with the three adjacent faces be compared with the acute angle which it makes with the three other faces, it is found that the average value of the former is less than $70^{\circ} 31' 44''$, and that of the latter is greater than $109^{\circ} 28' 16''$. BRAUNS drew the conclusion that the action of gravity is the disturbing cause; this is not perceptible in spinel and alum, but does come into evidence in the denser substance, lead nitrate.

The investigations of BRAUNS are the only precise and direct attempts to determine and explain the angular variations of cubic crystals. They lead to the conclusion that the planes of the crystal are octahedron faces, distorted by some cause which in the case of lead nitrate appears to be the action of gravity. The faces were all sufficiently good to yield measurements reliable to 1 minute, and the author makes no mention of multiple images, so that they were all presumably single plane surfaces, and were, therefore, regarded as not vicinal forms but true octahedron faces.

(2.) OBJECT OF THE PRESENT INVESTIGATION.

One serious difficulty underlies all attempts to study the problem by the ordinary methods of crystal measurement. Where several octahedron crystals, for example, are taken from a solution and found to give angles which are not the theoretical angles of the octahedron, it is impossible to ascertain whether any face of the one crystal corresponds exactly to any face of another. It occurred to me that the only way of studying changes in angle, and of investigating kindred problems, is to ascertain how far the variations are constant for one and the same crystal *during its growth*. For this purpose it will not suffice to take a crystal out of the solution and measure it, and then to re-immers the crystal, allow it to grow, and measure it again, for one is ignorant whether any faces of the nucleus are parallel to those of the shell by which it becomes enveloped; it is necessary to devise a plan by which one and the same crystal can be measured at different times during its growth in the solution.

This would further render it possible to trace the changes in the position of any given face as the crystal grows, and, if the changes are due to variations in the conditions of equilibrium between crystal and solution, might conceivably afford means for studying these conditions. Much has been written concerning internal structure of crystalline media, but it must not be forgotten that every point within a crystal has at some period been a point on its surface, and that our knowledge of the structure is very incomplete until the life-history of the crystal has been studied by observing the changes that take place at its surface and determining the conditions of equilibrium which obtain there.

In measuring crystals in the ordinary way it is very difficult to know whether the faces are plane and smooth until the crystal has been taken from the solution and dried, and then one cannot feel sure that their surface has not been altered by the evaporating solution during the process. By measuring crystals while still immersed in the solution this difficulty also would be obviated. I feared at first that when immersed in a medium of so high a refractive index as the saturated solution, the faces of a growing crystal would not yield sufficiently brilliant images of the collimator signal. This, however, is not the case; and having convinced myself by preliminary experiments that very good images can be obtained with the ordinary telescope and collimator, I had an instrument constructed which is really nothing more than a telescope-goniometer, inverted so that the crystal is suspended in the solution. Another advantage of this method is that the zone which is being measured has all its faces vertical, so that the possible distorting action of gravity is eliminated. The liquid is contained in a glass vessel with plane-parallel sides, through one of which the light enters normally from the collimator, while through another the reflected light emerges normally to enter the telescope.

A grant for the purpose having been obtained from the Royal Society in 1892, the goniometer was constructed according to my design by Messrs. TROUGHTON and SIMMS.

(3.) THE GONIOMETER.

The graduated circle of the goniometer, fig. 1 (Plate 13), rests upon a horizontal disc which is carried by two vertical metal columns about 20 centims. in height; these spring from the base plate of the instrument; and in an aperture in one of them is fixed the collimator. The vernier is engraved upon the rim of the fixed disc. The telescope is fitted to the lower end of a solid counterpoised arm, which can be rotated about the goniometer axis and clamped in any desired position. The crystal holder, which may consist of the usual centring and adjusting movements, is at the lower end of a vertical axle which passes through the centre of the goniometer disc, and may be raised or lowered by a screw with milled head, so as to bring the crystal into the horizontal plane of the telescope and collimator.* The axle of the crystal holder is clamped by a split ring grip above the holder. The glass trough which contains the solution is a square vessel 6 centims. square, with plane-parallel sides mounted in a brass frame; it stands upon a brass table, which can be raised or lowered by rack and pinion fitted below the base-plate, so as to bring the crystal into the solution or out of it. A brass guide upon the table receives one side of the frame,

* For economy of space, the centring movements in this instrument were not effected by the usual slides travelling between straight guides, but by two plane discs, which swing about pivots and move in contact with one another, as described for another instrument in 'Mineralogical Magazine,' vol. 10, 1887, p. 215,

and ensures that the trough shall be so placed as to have one of its faces perpendicular to the collimator tube.

The collimator being fixed, it may be desired to rotate either the crystal holder or the telescope while keeping the other parts fixed, or to rotate either of them together with the scale. For this purpose the usual clamping screws which bear upon the axle are dispensed with, and a circular metal disc, 15 centims. in diameter and 1 millim. thick, is provided, which may be clamped to the goniometer stand by one screw, to the telescope by a second screw, or to the crystal holder by a third screw. The disc is itself in rigid connection with the divided circle. Thus any two parts of the instrument may be coupled together, and it may be used either as a goniometer or a spectrometer. The telescope is clamped to the stand by a fourth screw with lever head.

Both telescope and collimator, as well as the eye-pieces, are mounted in collars provided with three screws, by which they may be fully adjusted. The telescope is also provided with a rack and pinion, so that it may, when used as a microscope, be moved towards or from the axis, and thus be focussed upon crystals immersed in liquids of different refractive indices. For the measurement of crystals growing in their solutions the crystal is fixed in a small clip made of stout platinum wire or ribbon; as the crystal grows the clip becomes enveloped by it and affords an absolutely rigid holder.

In addition to the ordinary eye-pieces, it was found necessary at an early stage of the research to provide a special eye-piece (fig. 2) for measuring the displacement of an image in any required direction within the field of view of the telescope. During the growth of a crystal the measurements can only be conveniently made in a single zone, and it is inadvisable to alter the adjustment of this zone during a series of observations. But, clearly, variations of angle may be due to the displacement of a face not only in the direction of a zone but out of it.

If a face has been adjusted so that the image *O* (fig. 2) of the square collimator signal is on the intersection of the cross wires, and if during the growth of the crystal the face alters its position slightly so that the image moves to *P* out of the horizontal zone *CC*, it will be sufficient to measure the distance *OP*, and the angle which the line *OP* makes with the horizontal cross wire, without moving the crystal at all. For this

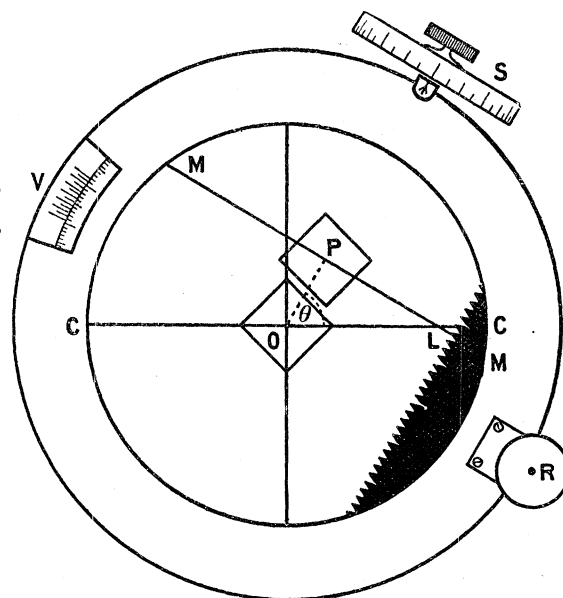

Fig. 2.

purpose the eye-piece is provided with an additional cross-wire MM, which can be moved across the field of view by a micrometer screw S, so that the angular value of any displacement along a diameter can be measured in terms of divisions upon the head of the drum at S. The movable wire, with its micrometer adjustment, is attached to a circular frame, C, which has a milled edge, and can be rotated about the centre O through any required angle; this frame is in the form of a case enveloping a circular disc which is graduated, and the angle through which it is turned is read by means of a vernier, V, engraved upon the side of an aperture cut in the case C, through which the scale is viewed. A toothed scale at L registers the number of complete turns which have been imparted to the micrometer screw, each interval corresponding to one turn. In this way the distance OP and the angle POC can be accurately measured. R is a screw by which the circle is clamped.

This eye-piece was subsequently described by Mr. TUTTON ('Phil. Trans.,' A, vol. 192, 1899, p. 463), who added it to his crystal-grinding apparatus; it would be a useful adjunct to any telescope goniometer.*

For the purpose of measuring crystals immersed in the mother-liquid, one face of the glass trough having been set perpendicular to the collimator, the telescope is set perpendicular to the adjacent face of the trough by the so-called Gauss method, *i.e.*, by viewing the image of the cross-wires reflected at its surface by means of the light derived from a lamp placed beside the telescope and sent down the telescope by a glass plate held obliquely in front of the eye-piece.

It was found advisable for the experiments described on pp. 493–515 to fix the trough on a table which can be adjusted by means of three screws, so that a side of the trough can be accurately set perpendicular to the telescope (see fig. 16, Plate 13).

The temperature of the solution is recorded by a thermometer immersed in it and clamped to the frame of the instrument, as shown in fig. 1, Plate 13.

(4.) PURPOSES FOR WHICH THE GONIOMETER CAN BE USED.

The goniometer here described can clearly be used for any work which the ordinary goniometer is required to perform. It can further serve several other purposes. Crystals can be measured, as in the present research, while immersed in a concentrated solution of their own material, and the changes of form which they experience during growth may thus be studied; deliquescent crystals, or such as are liable to alteration under ordinary conditions, can be measured while immersed in oil or in some other appropriate liquid; the action of solvents on crystals can be studied by measuring them while immersed in acids or other solvents, and this method affords the only safe means of ascertaining the angles made by the prismatic faces due to the

* Another telescopic adjunct, described in the same memoir by Mr. TUTTON, as devised by myself (p. 464), namely, the swinging lens before the eye-piece, was not, as might appear from his description, used with this instrument, but with another goniometer.

action of the solvent, with the original faces, when the latter have been removed by the solvent; the refractive indices of solid plates, prisms, or crystals can be measured by total reflection or minimum deviation by immersing them in appropriate liquids; and the refractive index of a liquid can similarly be measured by means of a plate or prism immersed in it.

Again, the angles of isomorphous mixtures may be ascertained as the composition changes, by measuring a crystal while in a solution of different composition; or measurements may be made of a crystal enveloping a similar crystal of a substance isomorphous with it by immersing the latter in a solution of the isomorphous material; this would render it possible to ascertain the angles between the faces of the shell and the corresponding faces of the kernel. Examples of some of these uses will be found in the following pages.

With the object of testing the goniometer, some observations were made upon the etching of calcite by dilute HCl, and upon the parallel growth of sodium nitrate with calcite. Since these are either new, or were new at the time when they were made (1893), and were certainly made by a new method, and since they bear upon the subject of vicinal faces, a few of the results of these measurements may be here mentioned.

(A.) *Etching of Calcite with HCl.*

A cleavage rhomb of calcite immersed in about 50 cub. centims. of water gave the following readings for two faces Rr :—

$$\left[\begin{array}{l} R \ 211^{\circ} \ 52\frac{3}{4}' \\ r \ 136^{\circ} \ 57\frac{1}{4}' \end{array} \right. \quad Rr = 74^{\circ} \ 55\frac{1}{2}'.$$

One drop of dilute HCl was added and after the lapse of $1\frac{1}{2}$ hours distinct pits were etched on both faces, having at first the form of linear channels parallel to the edge Rr , and subsequently assuming a more triangular outline, and faint images begin to make their appearance close to those from R and r . After 9 hours the following well-defined images were obtained in the zone $[Rr]$:—

$$\left[\begin{array}{l} R \ 211^{\circ} \ 51' \\ r \ 136^{\circ} \ 57' \\ r_1 \ 136^{\circ} \ 49' \end{array} \right. \quad rr_1 = 0^{\circ} \ 8'.$$

Another rhomb gave readings :—

$$\left[\begin{array}{l} R \ 42^{\circ} \ 37\frac{1}{2}' \\ r \ 327^{\circ} \ 41' \end{array} \right. \quad Rr = 74^{\circ} \ 56\frac{1}{2}' \text{ before etching.}$$

$$\left[\begin{array}{l} R' \quad 42^{\circ} 49' \\ r' \quad 327^{\circ} 47\frac{1}{2}' \end{array} \right. \quad R'r' = 75^{\circ} 1\frac{1}{2}' \text{ after etching.}$$

$$RR' = 0^{\circ} 11\frac{1}{2}',$$

$$rr' = 0^{\circ} 6\frac{1}{2}'.$$

In another series of experiments good readings were obtained from etched facets upon a cleavage rhomb immersed in very dilute acid; these were inclined to the cleavage faces at $0^{\circ} 13\frac{3}{4}'$ after 2 hours,

$$,, \quad 0^{\circ} 15\frac{3}{4}' \quad ,, \quad 4 \quad ,,$$

$$,, \quad 0^{\circ} 17\frac{3}{4}' \quad ,, \quad 8 \quad ,,$$

These images belong to facets lying in the zone Rr and are accompanied by other images not lying in this zone and belonging to facets on the other side of the triangular etched figures.

These and other experiments indicate that well-defined facets may be developed by the action of very dilute acid, but that they are inclined at different angles to the original face, and that the inclination of the etched facets changes as the etching proceeds, the value in general increasing.

(B.) *Parallel Growth of NaNO₃ with Calcite.*

A cleavage rhomb of calcite was adjusted and immersed in a concentrated solution of NaNO₃. The crystals of sodium nitrate which grew upon the surface of the calcite could not, of course, have all their faces parallel to those of the calcite, for the rhombohedron angle of calcite is $74^{\circ} 55'$, whereas that of sodium nitrate is $73^{\circ} 30'$.

It was found that the sodium nitrate always lies on the calcite in such a way that the two rhombohedra have one edge parallel, and generally also one face containing that edge in the sodium nitrate is parallel, or nearly parallel, to the corresponding face of the calcite. This result is in accordance with that arrived at in another way by O. MÜGGE, 'Neues Jahrbuch,' 1896 (2), p. 74.

It is also analogous to the union of twin crystals, in which the two individuals are not always exactly in the position demanded by the law of twinning but may deviate therefrom by several minutes or even by a degree or more. In these cases the deviation takes place in such a way that the crystals retain the parallelism of at least one face or one edge, as I have shown for Proustite and Bournonite.*

* 'Mineralogical Magazine,' vol. 6, 1884, p. 77; vol. 8, 1888, p. 75.

(5.) THE OCTAHEDRON ANGLE OF POTASH-ALUM.

A large number of observations were next made upon potash-alum with the object of discovering whether the octahedron angle of a crystal of this substance changes during the growth of the crystal, and if so, in what manner and to what extent.

The observations were carried out in the following way: a brilliant and uniform crystal having been selected, it was mounted in the platinum clip and adjusted on the instrument. The glass trough, filled with concentrated solution, and having a few small crystals in the bottom of the vessel, was then raised until the mounted crystal was completely immersed. Generally, the crystal would become slightly re-dissolved immediately after immersion, but it was constantly watched through the telescope until its faces began to grow in a uniform manner, and yielded brilliant reflections. It was then measured again and again at short intervals during many hours or at longer intervals during several days and nights.

The best sets of measurements were those obtained by immersing the crystal in slightly warmed and supersaturated solution and then observing it while the temperature was falling for several consecutive hours near an open window during a winter night. With a rise of temperature on the following day the crystal would become slightly etched and re-dissolved; but this made it possible to trace the changes of angle produced by incipient re-resolution, and then the phenomena of growth could be watched a second time upon the same crystal during the following night.

After once the crystal has grown sufficiently to envelope the platinum clip completely, there is no danger of its moving even to the smallest extent during any number of subsequent observations; it may be etched, partly re-dissolved, and allowed to grow again many times in succession without any change in its orientation.

When a crystal of potash-alum was watched in this way it was found:—

- (1) That the images from the various faces continually altered their positions;
- (2) That the angle between the adjacent faces was never the theoretical angle of the regular octahedron;
- (3) That the faces usually yielded multiple images lying very close together.

Thus, in the very first crystal measured, the following readings were obtained from two very good faces, A being a cube face and o an octahedron face.

$$\left[\begin{array}{l} o \ 181^{\circ} 10\frac{1}{4}', \\ A \ 126^{\circ} 25\frac{1}{2}'. \end{array} \right. \quad oA = 54^{\circ} 44\frac{3}{4}' \text{ (theoretical angle, } 54^{\circ} 44' 8''),$$

Next day

o	$181^{\circ} 20\frac{1}{2}'$	two images, one vertically above the other,	
A_1	$126^{\circ} 42\frac{1}{2}'$,	„ „ „	beside the other,
A_2	$126^{\circ} 39\frac{1}{2}'$.		
	$oA_1 = 54^{\circ} 38'$,	$oA_2 = 54^{\circ} 41'$,	

two hours later A yielded a single image, and $oA = 54^{\circ} 38\frac{1}{4}'$.

Another crystal yielded the following from a pair of adjacent brilliant octahedron faces, o and ω .

o_1	$96^{\circ} 49\frac{1}{2}'$	two images, one vertically above the other,	
o_2	$96^{\circ} 40'$	single image,	$o_1\omega_1 = 70^{\circ} 37'$,
ω_2	$26^{\circ} 21'$	„ „	$o_2\omega_2 = 70^{\circ} 19'$,
ω_1	$26^{\circ} 12\frac{1}{2}'$	two images, one vertically above the other.	

Two days later the readings had become

o_1	$96^{\circ} 49'$	not quite in the zone,	
o_2	$96^{\circ} 38'$	in the zone,	$o_1\omega_1 = 70^{\circ} 39'$,
ω_2	$26^{\circ} 24'$	not quite in the zone,	$o_2\omega_2 = 70^{\circ} 14'$,
ω_1	$26^{\circ} 10'$	„ „ „	

On the following day the readings were

o_1	$96^{\circ} 49'$	below the horizontal wire	$o_1\omega_2 = 70^{\circ} 27'$,
o_2	$96^{\circ} 46\frac{1}{2}'$	above „ „ „	$o_2\omega_2 = 70^{\circ} 24\frac{1}{2}'$,
o_3	$96^{\circ} 37\frac{1}{2}'$	on the horizontal wire	$o_3\omega_2 = 70^{\circ} 15\frac{1}{2}'$,
ω_2	$26^{\circ} 22'$	„ „ „	

A day later, in the morning

o_1	$96^{\circ} 49'$,		$o_1\omega_1 = 70^{\circ} 39'$,
o_2	$96^{\circ} 47'$	three overlapping images,	$o_3\omega_2 = 70^{\circ} 18'$,
o_3	$96^{\circ} 39'$,		
ω_2	$26^{\circ} 21'$	„ „ „	
ω_1	$26^{\circ} 10'$	two overlapping images.	

In the afternoon

$$\left[\begin{array}{ll} o_1 \ 96^\circ \ 44', & \\ o_2 \ 96^\circ \ 42' & o_1\omega_1 = 70^\circ \ 30', \\ \omega_2 \ 26^\circ \ 17' & o_2\omega_2 = 70^\circ \ 25', \\ \omega_1 \ 26^\circ \ 14'. & \end{array} \right.$$

On the following day

$$\left[\begin{array}{ll} o_1 \ 96^\circ \ 48' & \text{two overlapping images,} \\ o_2 \ 96^\circ \ 46' & o_1\omega_1 = 70^\circ \ 38', \\ o_3 \ 96^\circ \ 38' & o_3\omega_2 = 70^\circ \ 16', \\ \omega_2 \ 26^\circ \ 22' & \text{,, ,, ,,} \\ \omega_1 \ 26^\circ \ 10', & \end{array} \right.$$

and so on.

This example will serve to illustrate the difficulty of adjusting and measuring one of these crystals, for images which lie on the horizontal wire at one time are subsequently replaced by images slightly out of the zone. This difficulty necessitated the introduction of the micrometer eye-piece described above, but the observations were enough to show that each octahedron face of potash-alum is replaced by two, three, or more vicinal faces which continually change during growth.

I may now pass over a number of intermediate experiments, which ultimately suggested the correct interpretation of these multiple images, in order to state at once the explanation to which I was led, and will give one or two sets of experiments by which it is illustrated.

When an eye-piece of sufficient strength is employed, it is seen that many apparently simple images are in reality overlapping images lying very close together. These are usually three in number; one may be brighter than the others, and one or two of them may be so faint as to be almost invisible. Similarly, when the surface of the growing crystal is minutely examined,* and with a sufficient magnification, it is seen that corresponding to these three images are three reflecting surfaces; when the images are equally bright the octahedron face is seen to be replaced by three equal-sized facets of a very flat triakis-octahedron, as in fig. 3; when two are bright and the third is almost invisible, two of the faces are large and the third small (fig. 4); when the octahedron face apparently yields a single image, one facet is much larger than the other two, and gives an image in the zone if the arrangement is as in fig. 5, but an image situated below the zone if the arrangement is as in fig. 6.

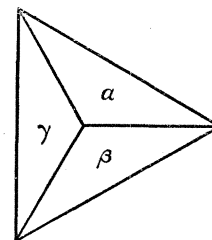

Fig. 3.

* This may very conveniently be done by a lens held in front of the eye-piece.

If figs. 5 and 6 represent two adjacent octahedron faces, they will appear to be single planes, and may give only single visible reflections, but they will not be inclined to each other at the theoretical angle of the regular octahedron. This will

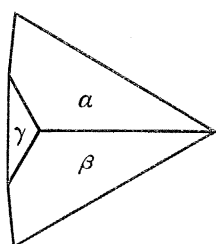

Fig. 4.

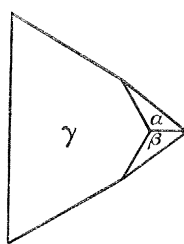

Fig. 5.

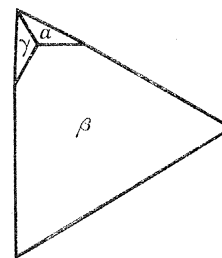

Fig. 6.

doubtless explain the deviations observed by BRAUNS and others. The octahedron angle of the second crystal, described on p. 470, would appear to possess various values ranging between $70^{\circ} 14'$ and $70^{\circ} 39'$, according to the time when the crystal was

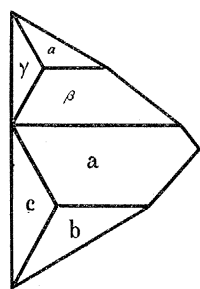

Fig. 7.

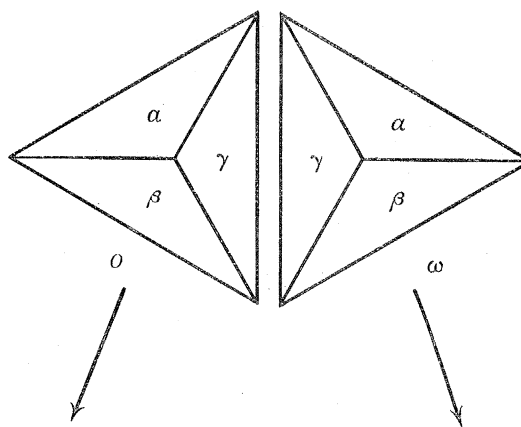

Fig. 8.

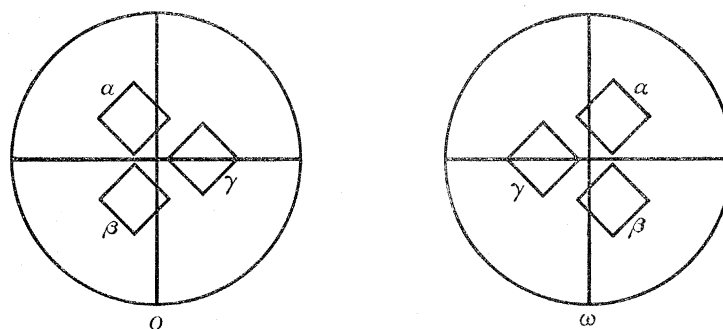

Fig. 9.

taken out of the solution if it were measured in the ordinary way, and these are angles of precisely the sort observed by BRAUNS.

When more than three images were yielded by an apparent octahedron face, they were found to be due to the fact that there were two or more triakis-octahedra;

these are generally two in number, one flatter than the other, and replacing the upper and lower portions of the large apparent octahedron face (fig. 7).

An apparent octahedron face of alum gives, therefore, in general, not one but three images. For the purpose of correct adjustment, and in order to distinguish easily between the various images, I have generally used a small square aperture as collimator signal in place of the customary Websky slit.

Two apparent faces, o , ω , of the octahedron (fig. 8), consisting in reality of the flat triakis-octahedron α , β , γ , will then give the reflections represented in fig. 9. The three images α , β , γ belonging to the face o are not necessarily separated from each other by the same intervals as those belonging to the face ω ; but the zone can be correctly adjusted by means of the images o_γ and ω_γ .

Example.

A very perfect octahedron, after 10 days' immersion in solution and various changes of temperature, was found on November 27, 1893, at 10 A.M., to yield three very well-defined images from each of the four octahedron faces in the adjusted zone (fig. 10).

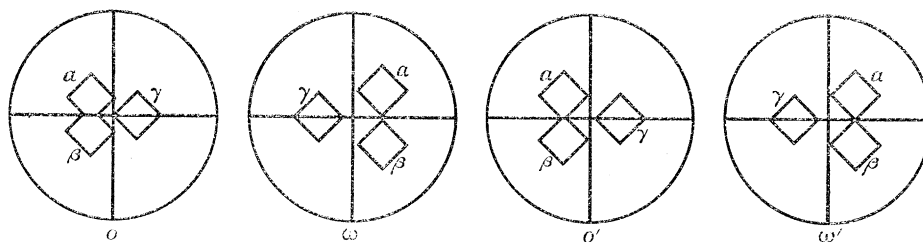

Fig. 10.

Calling these faces o , ω , o' , ω' respectively, the readings and images were as follows:—

$$\left[\begin{array}{l} o_\alpha = o_\beta = 328^\circ 5', \\ o_\gamma = 327^\circ 57\frac{1}{4}', \\ \omega_\gamma = 257^\circ 40\frac{1}{4}', \\ \omega_\alpha = \omega_\beta = 257^\circ 26\frac{1}{2}', \\ o'_\alpha = o'_\beta = 148^\circ 6\frac{1}{4}', \\ o'_\gamma = 147^\circ 56\frac{3}{4}', \\ \omega'_\gamma = 77^\circ 39\frac{1}{4}', \\ \omega'_\alpha = \omega'_\beta = 77^\circ 26\frac{1}{2}'. \end{array} \right. \quad \begin{array}{l} \text{(Here and in the} \\ \text{following pages } o_\alpha \\ \text{denotes the reading} \\ \text{for which the image} \\ \text{from } \alpha \text{ is on the} \\ \text{vertical wire.)} \end{array}$$

Here none of the measured angles is the true octahedron angle, but if we assume that the three faces α , β , γ of the triakis-octahedron replacing any one octahedron

face all belong to the same form, it is easy to calculate the theoretical readings for the true octahedron faces; they would be

$$\begin{aligned} o &= 328^\circ 2', \\ \omega &= 257^\circ 31', \\ o' &= 148^\circ 3', \\ \omega' &= 77^\circ 31'. \end{aligned} \quad \text{so that } \begin{cases} o\omega = 70^\circ 31', \\ o'\omega' = 70^\circ 32', \end{cases}$$

The angle ($\alpha\beta = \beta\gamma = \gamma\alpha$) of the triakis-octahedron replacing each octahedron face is also easily calculated, and is for the form replacing o $0^\circ 5'$,

$$\begin{array}{llll} & & & \omega \quad 0^\circ 9\frac{1}{4}', \\ & \text{,,} & \text{,,} & \\ & & & o' \quad 0^\circ 6\frac{1}{4}', \\ & \text{,,} & \text{,,} & \\ & & & \omega' \quad 0^\circ 8\frac{3}{4}'. \end{array}$$

This example indicates that—

- (1) The octahedron angle of the crystal is really the true octahedron angle ($70^\circ 31' - 70^\circ 32'$);
- (2) That there is a different flat triakis-octahedron replacing each face, although they only differ to a slight extent.

In this instance the images, α , β , γ , of each set seem to belong to the same form, for the α and β images are in the same vertical plane; but this is not always the case; the same crystal, measured on November 28, gave the following readings from o and ω (*cf.* figs. 11A, 11B):—

$$\left[\begin{array}{l} o_\beta = 290^\circ 58\frac{1}{2}', \\ o_\alpha = 290^\circ 55', \\ o_\gamma = 290^\circ 52\frac{3}{4}', \\ \omega_\gamma = 220^\circ 29\frac{1}{2}', \\ \omega_\beta = 220^\circ 22', \\ \omega_\alpha = 220^\circ 20\frac{1}{2}'. \end{array} \right.$$

Whereas from ω' $\omega'_\gamma = 40^\circ 30'$, $\omega'_\alpha = \omega'_\beta = 40^\circ 21'$.

Hence the reading for the true octahedron face ω' is $40^\circ 24'$; therefore the reading for ω is $220^\circ 24'$, and the three faces replacing ω are unequally inclined to ω , and do not belong to the same form (fig. 11A).

If it be true that the vicinal faces, whether they belong to the same or to different forms, are always triakis-octahedron faces, then of the faces replacing an octahedron plane which should yield an image at o one is always situated on the horizontal

wire $o\gamma$, and the other two on the lines $o\alpha$ and $o\beta$, which make an angle of 120° with $o\gamma$ in the field of view (fig. 12). This is a fact which is readily established by means of the micrometer eye-piece; the changes of the images, for example, during the growth of the crystal can be easily followed by the movable cross-wire when it has

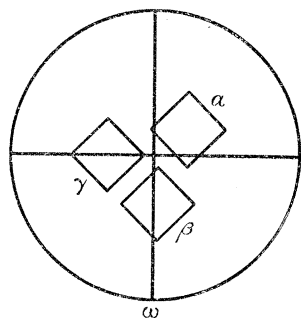

Fig. 11A.

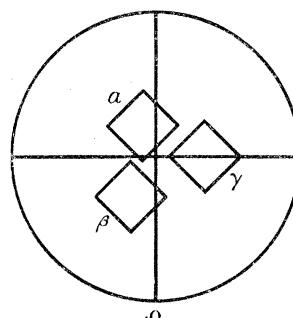

Fig. 11B.

been adjusted so as to run along the line $o\alpha$. This affords an even safer method of ascertaining the reading corresponding to the true octahedron face o ; for after it has been found that the images from the vicinal faces travel along the lines ao , βo , and γo , making angles of 120° with each other, the reading for the true octahedron is known to be that corresponding to their intersection o .

When examined in this way the two adjacent octahedron faces of potash-alum give readings which differ from each other by the true octahedron angle $70^\circ 31\frac{3}{4}'$ within errors of observation; it has thus been possible to measure with accuracy the octahedron angle of potash-alum, although the faces of the octahedron are not themselves present. It is not necessary to multiply examples: other crystals led to the same result as that just described: namely, that the octahedron angle of potash-alum is not liable to any variation, but that the octahedron faces themselves are absent and their place is supplied by vicinal planes belonging to triakis-octahedra which are liable to continual variations.

(6.) THE NATURE OF THE VICINAL FACES ON POTASH-ALUM AND AMMONIA-ALUM.

In the course of the present research many attempts were made to discover some regularity in the angles or in the indices of the vicinal faces. That they possess rational indices is rendered possible by the established fact that they lie in certain well-defined zones, but the indices are in that case very complicated. A very well-defined set of faces, for example, on one crystal represented a triakis-octahedron inclined at $6' 7''$ to the octahedron; its symbol would, therefore, be (hhl) , where $\frac{h}{l} = 1.00378$, or something approaching $(251.251.250)$; but it is impossible to say whether these are the indices to be adopted, or some other numbers having nearly the same ratio. Clearly the indices cease to be of much use when they are such

high numbers, and the position of the faces can be equally well and conveniently represented by their angles.

In a paper on the vicinal faces of celestite ('Zeits. f. Kryst.,' XI., 1886, p. 220), HINTZE suggested that their relations are better expressed by the angles that they make with each other than by the indices to which they can be referred; and, in fact, that they do not necessarily possess rational indices.

Whether this be so or not, it will be safer for the present purpose to define the vicinal faces of the growing alum crystal by their actual angles than by their possible indices. One reason why I am led to believe that they are really referable to rational, although not to simple, indices is the following:—During the growth of the crystal, one set of vicinal faces is being continually replaced by another along certain zones; each image of the collimator signal fades away like a dissolving view and another makes its appearance; but the change is not gradual, neither are the surfaces curved; one plane reflecting-surface is replaced by another plane; and although the images may for a time be multiple and confused, sharply defined images emerge successively by the substitution of one image for another *per saltum*. This extremely important fact is illustrated by some of the examples quoted above, and instances might be multiplied to any extent.

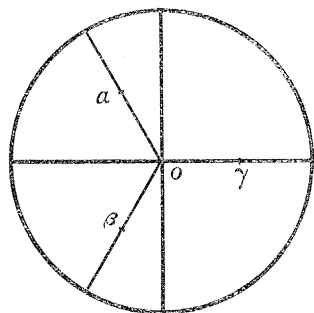

Fig. 12.

It is sufficient here to record the well-defined faces which have been observed during the experiments upon potash-alum and ammonia-alum.

If α , β , γ (fig. 12) be the three images obtained from three facets belonging to the same form, then if o be the position of the image which would be yielded by the ideal octahedron face, the readings actually made in the course of the observations are:—

- (1) That for which γ coincides with the vertical cross-wire;
- (2) That for which α and β simultaneously coincide with the vertical cross-wire.

The difference between these readings is nearly the angle between γ and the face which would truncate the edge $\alpha\beta$; if this face be called μ , the angle between γ and o , *i.e.*, the inclination of the vicinal form to the true octahedron, is given by

$$\tan \alpha\gamma = 2 \tan \alpha\mu.$$

For very small angles $\alpha\gamma$ may be taken as $\frac{2}{3}\gamma\mu$. The best readings obtained on a large number of crystals were the following:—

Potash-alum.		Ammonia-alum.	
$\gamma\mu$.	$o\gamma$.	$\gamma\mu$.	$o\gamma$.
2 15	1 30	1 45	1 10
3 15	2 10	3 0	2 0
4 45	3 10	8 30	5 40
6 0	4 0	16 0	10 40
7 30	5 0	17 0	11 20
8 15	5 30	21 0	14 0
9 0	6 0	22 30	15 0
12 0	8 0	24 30	16 20
13 0	8 40	26 30	17 40
15 0	10 0	27 15	18 10
19 30	13 0	28 30	19 0
20 0	13 20	31 0	20 40
21 0	14 0	—	—
22 30	15 0	—	—
24 30	16 20	—	—
25 15	16 50	—	—
28 0	18 40	—	—

and a number of intermediate values were obtained not quite so perfect. The largest values observed for $\gamma\mu$ were $0^\circ 33'$ on potash-alum, and $0^\circ 36'$ on ammonia-alum, corresponding to inclinations of $0^\circ 22'$ and $0^\circ 24'$, respectively, to the true octahedron face.

The following examples illustrate the differences in vicinal planes replacing the four octahedron faces of one and the same crystal of potash-alum at the same time :—

	Crystal I.	Crystal II.	Crystal III.	Crystal IV.
$o\gamma : o\mu$	$7\frac{3}{4}$	$6\frac{3}{4}$	$5\frac{1}{4}$	$28\frac{1}{2}$
$\omega\gamma : \omega\mu$	$13\frac{3}{4}$	$8\frac{1}{4}$	$2\frac{1}{4}$	$23\frac{1}{2}$
$o'\gamma : o'\mu$	$9\frac{1}{2}$	$5\frac{1}{2}$	$3\frac{1}{4}$	$25\frac{1}{4}$
$\omega'\gamma : \omega'\mu$	$12\frac{3}{4}$	$8\frac{1}{4}$	$4\frac{3}{4}$	28

Similarly on ammonia-alum :—

	Crystal I.	Crystal II.	Crystal III.
$o\gamma : o$	17	22	$31\frac{3}{4}$
$\omega\gamma : \omega\mu$	$24\frac{1}{2}$	31	36
$o'\gamma : o'\mu$	$24\frac{1}{2}$	24	$27\frac{1}{2}$
$\omega'\gamma : \omega'\mu$	$16\frac{1}{2}$	—	—

These examples indicate that the angle of the vicinal faces is generally of the same order of magnitude upon the different faces at any given time, but they do not indicate any cause for the differences, or any special regularity.

In K-alum I., II., opposite faces seem to show nearly the same form, which differs from that on the adjacent faces; but in K-alum IV., and Am.-alum I., the forms which most resemble each other are on adjacent faces.

It is quite clear, at any rate, that there is no constancy of angle in the vicinal faces either of K-alum or of Am.-alum.

Several attempts were made to determine whether, during the growth of a crystal, the changes are progressively in the same direction; whether the flat triakis-octahedron becomes more flat or more acute; also whether the angle varies in any way with the temperature or the barometric pressure.

The following observations on a crystal of ammonia-alum form a continuous and fairly lengthy series:—

\circ and ω are two adjacent octahedron faces and C is a cube face. \circ and ω both yielded two images, $\alpha\beta$, in the same vertical plane; C two images, $\alpha\beta$, nearly in a horizontal plane.

February 4, 1894.—The crystal was adjusted for a point halfway between \circ_a and \circ_β and a point halfway between ω_a and ω_β .

$$\left[\begin{array}{l} \circ_{\alpha\beta} = 139^\circ 18', \\ C_\beta = 84^\circ 31\frac{1}{4}', \\ \omega_{\alpha\beta} = 29^\circ 54', \\ \circ'_\gamma = 319^\circ 25\frac{3}{4}', \end{array} \right. \quad \text{all the images were very good.}$$

At 5 P.M. it was immersed in solution containing loose crystals.

Barometer 769.6 millim. ; $t = 12\frac{1}{2}^\circ$.

At 7.30 P.M.

$$\left[\begin{array}{l} \circ_{\alpha\beta} \ 139^\circ 20', \quad t = 12\frac{3}{4}^\circ, \\ \omega_{\alpha\beta} \ 29^\circ 56'. \end{array} \right.$$

At 10.0 P.M., $t = 12\frac{1}{4}^\circ$, \circ yielded two images.

$$\circ \left\{ \begin{array}{l} 139^\circ 20\frac{1}{4}', \\ 139^\circ 19\frac{1}{2}'. \end{array} \right.$$

The crystal having been withdrawn, the solution was then warmed to 35° and the crystal re-immersed at 11.15 when the temperature was 25° .

At 11.45 P.M., $t = 18^\circ$, the crystal was covered with etched triangles.

At 12.0 (midnight), $t = 17^\circ$, the etched figures were disappearing and ω gave a good reading at $29^\circ 54'$.

At 12.30 A.M., $t = 15\frac{1}{2}^\circ$, the faces were quite smooth.

THEORETICAL READINGS (from the angles
 $o_\gamma, o_{\alpha\beta}, \&c.$).

$$\left[\begin{array}{lll} o_\gamma & 139^\circ 34', & o = 139^\circ 23\frac{1}{3}', & oo_\gamma = 0^\circ 10\frac{2}{3}', \\ o_{\alpha\beta} & 139^\circ 18', & \omega = 29^\circ 55', & \omega\omega_\gamma = 0^\circ 9\frac{1}{2}', \\ \omega_{\alpha\beta} & 30^\circ 0', & o' = 319^\circ 24', & o'o'_\gamma = 0^\circ 12', \\ \omega_\gamma & 29^\circ 45\frac{1}{2}', & & \\ o'_\gamma & 319^\circ 36', & & \\ o'_{\alpha\beta} & 319^\circ 18'. & & \end{array} \right.$$

At 1.0 A.M.; $t = 15\cdot2^\circ$.

$$\left[\begin{array}{lll} \omega_\gamma & 29^\circ 42\frac{1}{4}', & \\ o'_\gamma & 319^\circ 38\frac{1}{2}', & \\ o'_{\alpha\beta} & 319^\circ 17\frac{1}{2}', & o' = 319^\circ 24\frac{1}{2}', & o'o'_\gamma = 0^\circ 14', \end{array} \right.$$

At 1.10 A.M.; $t = 14\cdot9^\circ$.

$$\left[\begin{array}{lll} \omega_{\alpha\beta} & 30^\circ 3', & \omega = 29^\circ 53\frac{1}{2}', & \omega\omega_\gamma = 0^\circ 19', \\ \omega_\gamma & 29^\circ 34\frac{1}{2}', & o' = 319^\circ 24\frac{1}{2}', & o'o'_\gamma = 0^\circ 16', \\ o'_\gamma & 319^\circ 40\frac{1}{2}', & & \\ o'_{\alpha\beta} & 319^\circ 16\frac{1}{2}'. & & \end{array} \right.$$

At 1.20 A.M.; $t = 14\cdot9^\circ$.

$$\left[\begin{array}{lll} o_\gamma & 139^\circ 35\frac{1}{2}', & o = 139^\circ 22\frac{1}{4}', & oo_\gamma = 0^\circ 13\frac{1}{4}'. \\ o_{\alpha\beta} & 139^\circ 16\frac{1}{4}', & & \\ \omega_{\alpha\beta} & 30^\circ 9\frac{1}{2}', & & \\ o'_{\alpha\beta} & 319^\circ 15\frac{1}{2}', & & \end{array} \right.$$

The solution was then withdrawn.

February 5.—The solution having been warmed to 35° was allowed to cool to 21° , and the crystal was immersed again at 5.30 P.M., when it at once began to grow.

At 6.30 P.M. ; $t = 17^\circ$, barometer 772 millim.

THEORETICAL READINGS.		
o_γ $139^\circ 34'$,	$o = 139^\circ 22\frac{3}{4}'$,	$oo_\gamma = 0^\circ 11\frac{1}{3}'$,
$o_{a\beta}$ $139^\circ 17'$,		
$\omega_{a\beta}$ $29^\circ 59'$,	$\omega = 29^\circ 53'$,	$\omega\omega_\gamma = 0^\circ 13\frac{1}{2}'$,
ω_γ $29^\circ 39\frac{1}{2}'$,		
o'_γ $319^\circ 33'$,	$o' = 319^\circ 22'$,	$o'o'_\gamma = 0^\circ 11'$.
$o'_{a\beta}$ $319^\circ 16\frac{1}{2}'$,		

At 6.45 P.M. ; $t = 15.8^\circ$.

$o_{a\beta}$ $139^\circ 14'$,	$\omega = 29^\circ 52'$,	$\omega\omega_\gamma = 0^\circ 15\frac{1}{2}'$,
$\omega_{a\beta}$ $30^\circ 0'$,		
ω_γ $29^\circ 36\frac{1}{2}'$,	$o' = 319^\circ 22'$,	$o'o'_\gamma = 0^\circ 19\frac{1}{2}'$,
o'_γ $319^\circ 41'$,		
$o'_{a\beta}$ $319^\circ 12\frac{1}{2}'$.		

At 7.10 P.M. ; $t = 15^\circ$.

o_γ $139^\circ 37'$,	$o = 139^\circ 22\frac{1}{3}'$,	$oo_\gamma = 0^\circ 14\frac{2}{3}'$,
$o_{a\beta}$ $139^\circ 15'$,		
$\omega_{a\beta}$ $30^\circ 2\frac{1}{2}'$,	$\omega = 29^\circ 52'$,	$\omega\omega_\gamma = 0^\circ 20\frac{1}{2}'$,
ω_γ $29^\circ 31\frac{1}{2}'$,		
o'_γ $319^\circ 41'$,	$o' = 319^\circ 22\frac{2}{3}'$,	$o'o'_\gamma = 0^\circ 17\frac{1}{3}'$.
$o'_{a\beta}$ $319^\circ 14'$,		

At 12.30 A.M. ; $t = 14.7^\circ$.

o_γ $139^\circ 37\frac{1}{2}'$,	$o = 139^\circ 22'$,	$oo_\gamma = 0^\circ 13\frac{1}{3}'$,
$o_{a\beta}$ $139^\circ 15\frac{1}{2}'$,		
ω_β $30^\circ 0\frac{1}{2}'$,	$\omega = 29^\circ 52\frac{1}{3}'$,	$\omega\omega_\gamma = 0^\circ 13\frac{1}{3}'$,
ω_a $29^\circ 59'$,		
ω_γ $29^\circ 40'$,	$o' = 319^\circ 23'$,	$o'o'_\gamma = 0^\circ 18'$.
o'_γ $319^\circ 41'$,		
$o'_{a\beta}$ $319^\circ 15'$,		

The following table sums up the results of these observations, showing the gradual

change in the angles made by the vicinal faces with the octahedron face they replace :—

t .	oo_{γ} .	$\omega\omega_{\gamma}$.	$o'o'_{\gamma}$.
15·5	$10\frac{2}{3}$	$9\frac{1}{2}$	12
15·2	—	—	14
14·9	$13\frac{1}{4}$	19	16
17	$11\frac{1}{3}$	$13\frac{1}{2}$	11
15·8	—	$15\frac{1}{2}$	$19\frac{1}{2}$
15	$14\frac{2}{3}$	$20\frac{1}{2}$	$17\frac{1}{3}$
14·7	$13\frac{1}{3}$	$13\frac{1}{3}$	18

This indicates that, as the temperature falls, the vicinal forms become in general more acute, their faces make larger angles with each other, but the angle does not depend entirely upon the temperature. At $15\frac{1}{2}^{\circ}$, for example, $\omega\omega_{\gamma}$ is at one time $9\frac{1}{2}'$, at another time something between $15'$ and $20'$.

The same results were obtained from many other similar series of observations. Variations of barometric pressure also seemed to be without effect upon the angles of the vicinal faces.

One suggestive feature was found to be common to many of the experiments ; it sometimes happens that an octahedron face is replaced by two different vicinal forms, one replacing the upper and the other the lower part of the face as it stands vertically in the solution (fig. 13) ; in such a case it was invariably found that the triakis-octahedron on the lower part of the face is slightly flatter than that of the upper part. For example, a crystal of ammonia-alum, immersed at midnight, $t = 18\cdot9^{\circ}$, barometer 759 millims., gave at 1.30 A.M. the following readings for two apparently perfect octahedron faces o and ω and for the cube face A between them.

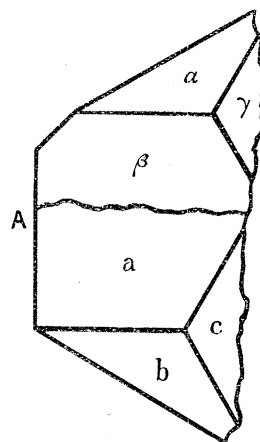

Fig. 13.

$$\begin{aligned} o_a & 356^{\circ} 16', \\ A & 301^{\circ} 42\frac{1}{2}', \\ \omega_a & 247^{\circ} 6'. \end{aligned}$$

Shortly afterwards ω broke up into three images $\alpha \beta \gamma$, giving the readings

$$\begin{aligned} \omega_{\alpha\beta} & = 247^{\circ} 2', \\ \omega_{\gamma} & = 246^{\circ} 46', & \omega & = 246^{\circ} 56\frac{2}{3}', & \omega\omega_{\gamma} & = 0^{\circ} 10\frac{2}{3}'. \end{aligned}$$

At 2.30 A.M., $t = 17^{\circ}9$, the readings were

$$\left[\begin{array}{lll} o_{\gamma} & 356^{\circ} 21', & o = 356^{\circ} 15\frac{1}{2}', & oo_{\gamma} = 0^{\circ} 6', \\ o_{a\beta} & 356^{\circ} 12\frac{1}{2}', & & \\ A & 301^{\circ} 36', & & \\ \omega_{a\beta} & 247^{\circ} 4\frac{1}{4}', & \omega = 246^{\circ} 56\frac{3}{4}', & \omega\omega_{\gamma} = 0^{\circ} 15', \\ \omega_{\gamma} & 246^{\circ} 41\frac{3}{4}', & & \\ \omega'_{a\beta} & 67^{\circ} 0', & \omega' = 66^{\circ} 54\frac{1}{3}', & \omega'\omega'_{\gamma} = 0^{\circ} 11\frac{1}{3}', \\ \omega'_{\gamma} & 66^{\circ} 43'. & & \end{array} \right.$$

In addition to these images there were also three close to ω_a , ω_b and ω_c , and proceeding from the lower part of the face (fig. 13); calling these ω_a , ω_b and ω_c , the following measurements were obtained:—

At 2.30 A.M.

$$\left[\begin{array}{l} A \ 301^{\circ} 35\frac{3}{4}', \\ \omega_c \ 246^{\circ} 47\frac{1}{2}', \\ \omega_{\gamma} \ 246^{\circ} 41\frac{1}{4}'. \end{array} \right.$$

At 2.55 A.M., $t = 17^{\circ}2^{\circ}$

$$\left[\begin{array}{l} A \ 301^{\circ} 36\frac{1}{2}', \\ \omega_{\beta} \ 247^{\circ} 7\frac{1}{4}', \\ \omega_c \ 246^{\circ} 46\frac{3}{4}', \\ \omega_{\gamma} \ 246^{\circ} 40\frac{3}{4}', \quad \therefore \omega = 246^{\circ} 58\frac{1}{4}'. \end{array} \right.$$

So that $\omega\omega_{\gamma} = 0^{\circ} 17\frac{1}{2}'$ and a, b, c is a flatter form than α, β, γ .

Observations of GOUY and CHAPERON and others have shown that solutions are more concentrated in their lower than in their upper layers, and this is of course the case in the present experiments where crystals lie at the bottom of the trough.

The case just quoted, and others like it, suggest that the vicinal form is flatter where the solution is more concentrated. Accordingly many experiments were made in which the trough was successively raised and lowered in order to ascertain the effect of immersing the same crystal to a greater or less depth in the solution.

A crystal of potash-alum gave readings

$$\left[\begin{array}{ll} o_{a\beta} \ 290^{\circ} 58\frac{1}{2}', & o_{\gamma}o_{a\beta} = 0^{\circ} 7', \\ o_{\gamma} \ 290^{\circ} 51\frac{1}{2}'. & \end{array} \right.$$

When immersed deeper they became

$$\left[\begin{array}{ll} o_{a\beta} \ 290^{\circ} 58\frac{1}{4}', & o_{\gamma}o_{a\beta} = 0^{\circ} 6\frac{1}{2}', \\ o_{\gamma} \ 290^{\circ} 51\frac{3}{4}'. & \end{array} \right.$$

Another crystal of potash-alum, having been adjusted near the surface of the solution, was immersed to a considerable depth; the image from a brilliant facet was found to move through $0^\circ 22'$ (as measured by the micrometer eye-piece) in the direction of a flattening of the form.

A third crystal gave near the surface of the liquid

$$\left[\begin{array}{ll} \omega_\alpha 208^\circ 46\frac{1}{2}', & \omega_\alpha\omega_\gamma = 0^\circ 16\frac{1}{2}', \\ \omega_\beta 208^\circ 43\frac{1}{2}', & \omega_\beta\omega_\gamma = 0^\circ 13\frac{1}{2}', \\ \omega_\gamma 208^\circ 30'. & \end{array} \right.$$

At a greater depth

$$\left[\begin{array}{ll} \omega_{\alpha\beta} 208^\circ 39', & \omega_{\alpha\beta}\omega_\gamma = 0^\circ 7', \\ \omega_\gamma 208^\circ 32'. & \end{array} \right.$$

Raised to the surface again

$$\left[\begin{array}{ll} o_\gamma 138^\circ 11\frac{3}{4}', & o_\gamma o_\beta = 0^\circ 13\frac{1}{4}', \\ o_\beta 137^\circ 58\frac{1}{2}'. & \end{array} \right.$$

Depressed again

$$\left[\begin{array}{ll} o_\gamma 138^\circ 8', & o_\gamma o_\beta = 0^\circ 9\frac{1}{4}', \\ o_\beta 137^\circ 58\frac{3}{4}'. & \end{array} \right.$$

The above experiments indicate that in crystals of potassium- or ammonium-alum the vicinal faces, which invariably replace the octahedron planes, belong to different forms $\{hhl\}$ of flat triakis-octahedra, and that, as the crystal grows, these continually change their inclinations; the faces α , β , γ , which replace an octahedron face o , generally belong to the same form, and they make an angle of from $2'$ to $30'$ with o ; when the vicinal facets at the top of the crystal belong to a different form from those at the bottom they generally make a larger angle than the latter with o ; similarly as the crystal is immersed deeper in the solution the vicinal form becomes flatter; during the growth of a crystal in a cooling solution the vicinal form usually becomes more acute; but at different times quite different vicinal faces may grow at the same temperature.

(7.) THE VICINAL FACES ON SODIUM CHLORATE, ZINC SULPHATE, AND MAGNESIUM SULPHATE.

(A.) *Sodium Chlorate.*

Cubes of sodium chlorate give multiple images which, in accordance with their symmetry, are usually two images in a horizontal plane yielded by one pair of cube

faces, and two images in a vertical plane yielded by the alternate pair, indicating vicinal faces belonging to a form $\{hk0\}$ (fig. 14).

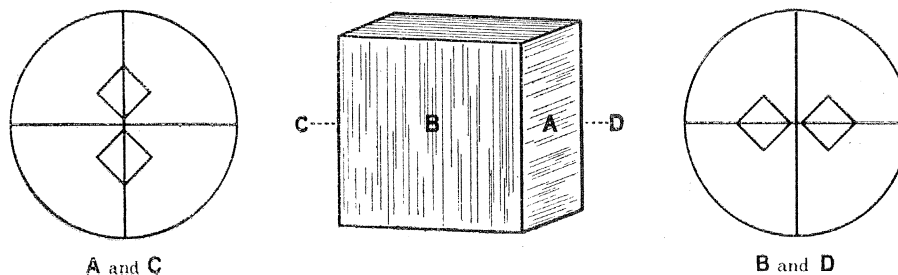

Fig. 14.

Sometimes they are situated obliquely and correspond to two faces of $\{hkl\}$, replacing each cube face.

The following series will serve as an illustration of the results obtained with this substance:—

November 11, 1897.

At 12.45 P.M.; $t = 17.6^\circ$.

A	93° 17';	image 10' 26''	below zone.		
B	183° 14';	,, 10' 26''	,,	,,	
A'	273° 16';	,, 3' 42''	,,	,,	
B' _a	3° 14';	,, . . .	on	,,	} ∴ B' = 3° 17½'.
B' _β	3° 21';	,, . . .	,,	,,	

After slight re-adjustment:—

At 2.15 P.M.; $t = 17^\circ$.

B' _a	3° 36'	} from the upper part of the face.	} All 5' 40'' below the cross-wire.
B' _β	2° 59'		
B' _γ	3° 27'	} ,, ,, lower ,, ,, ,,	
B' _δ	3° 10'		

At 4.15 P.M.; $t = 17^\circ$.

A _α	93° 25',
A _β	93° 24'; image 20' 0'' below the cross-wire.

After further readjustment :--

At 4.45 P.M. ; $t = 17^\circ$.

Approximate readings for true cube faces are therefore

A_α	$93^\circ 26'$;	image $11' 10''$ above cross-wire.
A_β	$93^\circ 25'$;	„ $7' 10''$ below „
B'_α	$3^\circ 31'$;	„ . . . on the „
B'_β	$3^\circ 28'$;	„ . . . „ „
A'_α	$273^\circ 26'$;	„ . . . „ „
A'_β	$273^\circ 19'$;	„ $3' 20''$ above „
B_α	$183^\circ 31'$;	„ $4' 10''$ below „
B_β	$183^\circ 28'$;	„ $1' 50''$ above „

$$A = 93^\circ 25\frac{1}{2}'$$

$$B' = 3^\circ 29\frac{1}{2}'$$

$$A' = 273^\circ 22\frac{1}{2}'$$

$$B = 183^\circ 29\frac{1}{2}'$$

The crystal was re-immersed at 9.45 P.M. ; $t = 18^\circ$. At 10.15 P.M. ; $t = 18^\circ$; the images from B indicated a re-entrant angle.

B_α	$183^\circ 40'$.
B_β	$182^\circ 58'$.
A_α	$93^\circ 31'$. . . A_α two images ; one $10'$ below, the other $14' 40''$ above
A_β	$93^\circ 14'$. . . A_β „ „ „ „ „ „

$$\therefore B = 183^\circ 19' ; A = 93^\circ 22\frac{1}{2}' ; \text{ and } AB = 89^\circ 56\frac{1}{2}'$$

This example illustrates the difficulty of adjusting correctly a crystal which is liable to the growth of vicinal faces, and the impossibility of measuring accurately the angles between the faces of the simple forms which are replaced by them, except by tracing these changes. In sodium chlorate the vicinal faces sometimes belong to the form $\{h k 0\}$, and they make angles of from 3 to 10 minutes with the ideal cube face ; they sometimes make re-entrant angles with each other, but the difficulties of adjustment and measurement are increased by the fact that the vicinal faces often belong to various forms $\{h k l\}$, and are unequally inclined to the cube faces. The same general features hold as for alum : the vicinal forms usually become more acute as the growth proceeds ; and they are less acute for the parts of the crystal which are most deeply submerged. A cube face of the crystal just described, for example, gave on May 27, 1899, two images separated by $2\frac{1}{2}$ minutes when at a depth of about 1 inch, and two images separated by 12 minutes near the surface of the solution.

Zinc Sulphate and Magnesium Sulphate.

That the same features are also exhibited by crystals belonging to other systems than the cubic, was proved by experiments on these two substances.

The following are examples of measurements upon them:—

ZINC Sulphate; prism zone; $m = M = \{110\}$, $B = \{010\}$, $A = \{100\}$.

On the following day:—

$$\begin{array}{l}
 \left[\begin{array}{l}
 M \left\{ \begin{array}{l} 187^\circ 24', \\ 186^\circ 41', \end{array} \right. \\
 m \left\{ \begin{array}{l} 97^\circ 56', \\ 97^\circ 53', \end{array} \right. \\
 B \quad 52^\circ 19', \\
 M' \left\{ \begin{array}{l} 6^\circ 41', \\ 6^\circ 36', \end{array} \right. \\
 m' \quad 277^\circ 56', \\
 B' \quad 232^\circ 19',
 \end{array} \right. \left[\begin{array}{l}
 Bm = 45^\circ 37' \text{ to } 45^\circ 34', \\
 BM' = 45^\circ 38' \text{ ,, } 45^\circ 33', \\
 B'm' = 45^\circ 37'.
 \end{array} \right.
 \end{array}$$

$$\begin{array}{l}
 \left[\begin{array}{l}
 M \left\{ \begin{array}{l} 187^\circ 10', \\ 186^\circ 42', \\ 186^\circ 39', \end{array} \right. \\
 m \left\{ \begin{array}{l} 97^\circ 53', \\ 97^\circ 21', \end{array} \right. \\
 B \left\{ \begin{array}{l} 52^\circ 16', \\ 52^\circ 8', \end{array} \right. \\
 M' \left\{ \begin{array}{l} 6^\circ 41', \\ 6^\circ 39', \end{array} \right. \\
 A' \left\{ \begin{array}{l} 322^\circ 19', \\ 322^\circ 17', \end{array} \right. \\
 \\
 m' \left\{ \begin{array}{l} 277^\circ 56', \\ 277^\circ 52', \\ 277^\circ 25', \\ 277^\circ 19', \end{array} \right.
 \end{array} \right. \left[\begin{array}{l}
 Bm = 45^\circ 41' \text{ to } 45^\circ 9', \\
 B = 52^\circ 12', \\
 BM' = 45^\circ 31' \text{ to } 45^\circ 33', \\
 A' = 322^\circ 18'.
 \end{array} \right.
 \end{array}$$

The value generally given for the prism angle of zinc sulphate is $91^\circ 12'$; in the above crystal various vicinal prism forms are indicated, the angles of which would range from $91^\circ 6'$ to $91^\circ 15'$ even for the best faces.

MAGNESIUM Sulphate; prism zone; $m = M = \{110\}$.

8.20 P.M.; $t = 16.5^\circ$.

$$\left[\begin{array}{l}
 M \quad 12^\circ 30\frac{1}{2}', \\
 m' \quad 282^\circ 59'.
 \end{array} \right.$$

9.30 P.M.; $t = 16.5^\circ$.

$$\left[\begin{array}{l}
 m \quad 102^\circ 49' \text{ above zone,} \\
 M \quad 12^\circ 32', \\
 m' \quad 283^\circ 8\frac{1}{2}', \text{ three images in vertical plane,} \\
 M' \quad 192^\circ 26\frac{1}{2}' \text{ below zone.}
 \end{array} \right.$$

10.30 P.M. ; $t = 16.5^\circ$.

$$\left[\begin{array}{l} m \left\{ \begin{array}{l} 103^\circ 3', \\ 102^\circ 50', \end{array} \right. \\ M \left\{ \begin{array}{l} 12^\circ 32\frac{1}{2}', \\ 12^\circ 25', \\ 12^\circ 17', \end{array} \right. \\ m' \left\{ \begin{array}{l} 283^\circ 8', \\ 282^\circ 55', \end{array} \right. \\ M' 192^\circ 17'. \end{array} \right.$$

The value generally given for the prism angle of magnesium sulphate is $90^\circ 35'$. The above observations indicate vicinal planes belonging to prisms whose angle would differ from this by more than $20'$.

I have given these two examples from the orthorhombic system in order to point out how the mean of a number of measurements may with crystals of comparatively low symmetry give a result very far from the truth. In alum, although the true octahedron angle might never be observed, the mean of a sufficiently large number of measurements would probably give the exact octahedron angle, for the three vicinal planes which replace the octahedron face are, *by the symmetry of the crystal*, inclined to it in three different directions, so that some of the measured angles are too large and some too small. But in the case of a rhombic prism, each face would, in accordance with the symmetry of the crystal, be replaced by only one vicinal plane, and the prism angle, as measured, would be consistently either too large or too small. The true position of the prism face could not be ascertained, as that of the octahedron face was in alum, by the convergence upon it of three zones of vicinal faces, and by the limit to which they tend.

To determine with absolute accuracy the true angles of such crystals it would be necessary to study the variations of their vicinal faces in the manner described above—but by means of a two-circle or three-circle goniometer.

A number of observations were also made upon crystals of sodium arsenate as an example of a substance belonging to the monoclinic system : but since they do not affect the general results they are not described in the present paper.

(8.) THE EFFECT ON ALUM OF DILUTING THE SOLUTION.

During the experiments described in this paper there were naturally many occasions on which the crystal was not growing in a saturated or supersaturated solution, but was being corroded by a more dilute medium, and in such cases it was sometimes possible to obtain quite good reflections from the prerrosion faces ; several experiments were also made in which the solution was purposely diluted or warmed in order to observe the etched faces.

In the case of a bright octahedron of alum, the first effect of slight dilution or warming is to develop small pits having the form of equilateral triangles inscribed in the triangle which bounds the octahedron face; the triangles are small shallow pits and their sides must therefore be vicinal faces, which are still triakis-octahedra, like those of the growing crystal.

Sometimes the growing crystal has its octahedron face covered with flat triangular plates whose outline is parallel to that of the octahedron face; when the solution is diluted, these have their corners rounded and become converted into hexagonal plates, then disappear and become replaced by the inscribed triangular pits.

In one case the prerision faces (belonging to a triakis octahedron) on one octahedron face made an angle of $0^{\circ} 57'$ with each other; the crystal was then allowed to grow during the night, and in the morning well defined vicinal planes had made their appearance, making an angle of $0^{\circ} 15'$ with each other; as the temperature rose these were replaced by prerision faces belonging to different forms; that on one edge being inclined at about $0^{\circ} 5'$ to the true octahedron, and that on the adjacent edge at about $0^{\circ} 18'$. This feature was observed in other etching experiments; the prerision faces replacing an octahedron face generally belong to different forms, whereas the vicinal planes of growth generally belong to the same form.

In one case two well defined prerision faces belonging to the form $\{221\}$ made their appearance upon an octahedron edge, inclined at $15^{\circ} 46'$ and $15^{\circ} 41'$ respectively, to the adjacent octahedron faces: the theoretical angle for $\{221\}$ is $15^{\circ} 47' 36''$.

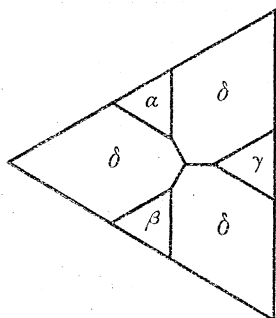

Fig. 15.

The prerision faces δ which replace the edges of the vicinal triakis octahedron α, β, γ of fig. 15 belong to a different form, the icositetrahedron; and, since the first effect of etching is to round off the edges of the crystal, it generally results in the production of such icositetrahedra; but they do not necessarily truncate the edges α, β , &c. Thus the crystal just mentioned yielded the following results three days later, when the corroding action of the solvent happened to be extremely slow.

November 27, 1893.—At 10 A.M., each octahedron face yielded three very perfect images; the actual readings are given on p. 473. A little later, the form replacing α was measured and was found to be a triakis-octahedron inclined at $4\frac{3}{4}'$ to α (previously determined as $5'$). At 10.45 the edges of this vicinal form were replaced by facets of an icositetrahedron δ inclined at almost exactly the same angle to α ; and the same thing happened on the other faces of the crystal. The angle between δ and the true octahedron face was measured as $0^{\circ} 2'$ on α ; $0^{\circ} 4'$ on ω' ; $0^{\circ} 3\frac{1}{2}'$ on σ' . The triangular etched pits did not begin to make their appearance until 3.15 P.M.

On the following day the same events recurred: the vicinal faces of growth replacing α belonged to a triakis-octahedron inclined to α at $0^{\circ} 2\frac{1}{2}'$, and at 11.15 A.M. the edges of this form were replaced by prerision faces belonging to an

icositetrahedron inclined to σ at $0^\circ 3\frac{1}{2}'$. It is, no doubt, the development of such faces which converts the triangular plates of growth into hexagonal plates, as described above.

These and other instances indicate that the first effect of slow solution is to produce prerision faces on the edges of the crystal; on the octahedron edge these belong to triakis-octahedra; on the edges of the vicinal faces they belong to icositetrahedra. The latter are inclined to the octahedron at about the same angle as the triakis-octahedron, and they certainly do not truncate its edges. The next effect of the process of solution is to produce etched triangular pits bounded by flat triakis-octahedra.

(9.) SOME POSSIBLE CAUSES OF THE VARIATIONS.

With all the substances examined, as with alum, vicinal faces are the rule; they change their position as the crystal grows; they continue to deviate more widely from simple forms, at any rate during the initial growth; the reflections move or oscillate generally in well defined zones, and in accordance with the symmetry of the crystal; their movement is not gradual but *per saltum*; their deviation from the simple forms which they replace generally amounts to from 3 to 20 minutes.

In making the observations great care must be exercised lest deviations due to refraction through layers or currents of more or less concentrated liquid be mistaken for those due to the change of inclinations in the vicinal faces. Such currents are always streaming round a growing crystal, and do produce visible displacements of the images; but these displacements are rather of the nature of irregular oscillations, and may be detected with a little practice.

When beginning the study of alum, I endeavoured to eliminate the action of these currents with the object of ascertaining whether the production of the vicinal faces might not be actually due to them. By means of a suitable clockwork arrangement a wooden vane with four arms was kept revolving in a beaker full of concentrated alum solution during several hours, so as to keep the liquid continually stirred. Small alum crystals were allowed to crystallise on the vane, and were examined at intervals. I came to the conclusion that the crystals were equally perfect, and possessed vicinal faces of the same sort, whether they crystallised in a still solution or in one which was kept continually stirred. In the same way the stirring of the liquid in the goniometer trough seemed to produce no appreciable effect upon the nature of the vicinal faces on a crystal of alum which had been growing in the still solution; the introduction of a stirrer into the trough did not affect the smoothness or the angles of the faces so far as could be observed; the experiments are, however, difficult to carry out, and it is of course impossible to make accurate measurements while the liquid is in violent motion, although the crystal itself is not disturbed.*

* Other and more precise experiments of this nature are described below on p. 518.

Among other possible causes to which the production of particular vicinal forms might be ascribed are—(1) the temperature at which growth is taking place, (2) the rate at which the temperature is changing. It became important to examine next how far these two factors might contribute to the results observed.

From the example quoted on p. 479 and from other similar examples we may endeavour to trace a connection between the angle of the vicinal form in alum and the rate of fall of temperature. α represents the theoretical octahedron face, γ the vicinal plane.

SERIES I.—Potash-alum.

Time.	Temperature.	$\alpha\gamma$ (mean).	$\alpha\gamma$ (actual values).		
12.30	15°·5	0 11'	10 $\frac{2}{3}$ '	9 $\frac{1}{2}$ '	12'
1.0	15·2	14'			14'
1.10	14·9	17 $\frac{1}{2}$ '	19'		16'
1.20	14·9	13 $\frac{1}{4}$ '			13 $\frac{1}{4}$ '

Hence a fall of about 0·6° in 50 minutes gives as average $\alpha\gamma = 14'$, ranging from 9 $\frac{1}{2}$ ' to 19 minutes.

Temperature nearly stationary at 14·9° gives $\alpha\gamma = 13\frac{1}{4}'$.

SERIES II.—Potash-alum.

Time.	Temperature.	$\alpha\gamma$ (mean).	$\alpha\gamma$ (actual values).		
6.30	17°	0 12'	11 $\frac{1}{3}$ '	13'	11'
6.45	15·8	17 $\frac{1}{4}$ '	15 $\frac{2}{3}$ '	19'	
7.10	15	17 $\frac{1}{2}$ '	14 $\frac{2}{3}$ '	20 $\frac{2}{3}$ '	16'
12.30	14·7	15'	13 $\frac{1}{3}$ '	13 $\frac{1}{3}$ '	17 $\frac{2}{3}$ '

Hence a fall of 2° in 40 minutes gives as average $\alpha\gamma = 16'$, ranging from 11 to 20 $\frac{2}{3}$ minutes.

Temperature nearly stationary at 14·7° gives $\alpha\gamma = 15'$.

SERIES III.—Potash-alum.

Time.	Temperature.	$\alpha\gamma$ (mean).	$\alpha\gamma$ (actual values).		
2.10	18°·3	0 10 $\frac{1}{2}$ '	10 $\frac{1}{2}$ '	'	'
2.20	17·9	9 $\frac{1}{2}$ '	15'	2 $\frac{3}{4}$ '	11 $\frac{1}{2}$ '

Hence a fall of 0·4° in 10 minutes gives as average $\alpha\gamma = 10'$, ranging from 2 $\frac{3}{4}$ ' to 15 minutes.

THE VARIATION OF ANGLES OBSERVED IN CRYSTALS.

491

SERIES IV.—Ammonia-alum.

Time.	Temperature.	$\alpha\gamma$ (mean).	$\alpha\gamma$ (actual values).
9.10	15°·1	0 13	21½ 4⅔ ' '
11.25	14·5	18	17⅓ 13 22 19⅓
1.15	14·3	16½	13⅔ 19⅓

Fall of 0·8° in 240 minutes gives as average $\alpha\gamma = 16'$, ranging from 4⅔ to 22 minutes.

Temperature nearly stationary at 14·3° gives $\alpha\gamma = 16½'$.

SERIES V.—Ammonia-alum.

Time.	Temperature.	$\alpha\gamma$ (mean).	$\alpha\gamma$ (actual values).
11.15	12°·2	0 21	21 24 18⅓
12.45	12·1	16½	18 15⅓

Fall of 0·1° in 90 minutes gives as average $\alpha\gamma = 18⅔'$.

Temperature nearly stationary at 12·1° gives $\alpha\gamma = 16½'$.

SERIES VI.—Ammonia-alum.

Time.	Temperature.	$\alpha\gamma$ (mean).	$\alpha\gamma$ (actual values).
11.30	18°	0 23⅓	23⅓ ' '
12.0	16·3	20½	22⅔ 18⅔

Fall of 1·7° in 30 minutes gives an average $\alpha\gamma = 21⅔'$.

SERIES VII.—Ammonia-alum.

Time.	Temperature.	$\alpha\gamma$ (mean).	$\alpha\gamma$ (actual values).
11.0	12°·8	0 14½	16⅓ 13
11.30	12·8	13	15 11

Temperature nearly stationary at 12·8° gives $\alpha\gamma = 13½'$.

From the above observations it is very difficult to draw any definite general conclusions, since the differences between the various angles in the same crystal are greater than the differences between the mean values in different crystals. This may indicate that the variations are mainly due to local causes.

On the whole, the angle made by the vicinal forms with the octahedron is perhaps slightly greater when the temperature is falling rapidly; and for stationary temperatures it is perhaps slightly greater for low than for high temperatures; but the differences are very small, if, indeed, they really exist, and in many cases quite different vicinal faces are developed at the same temperature, so that in any case the angle of the vicinal form can hardly be a direct result of the particular temperature at which it was produced.

Having found, however, that there seemed to be a general relationship between the acuteness of the vicinal faces and the depth at which the crystal was growing in the solution, I was naturally led next to enquire whether one determining factor is not the concentration of the solution; it is certain that the concentration varies slightly with the depth, especially in solutions which contain loose crystals at the bottom of the trough, and the concentration seemed to be one of the variable factors capable of accounting for the changes of angle.

PART II.

THE CONCENTRATION OF THE SOLUTION IN CONTACT WITH A GROWING CRYSTAL.

(A.) *Preliminary Experiments.*

It was pointed out above that in studying the growth of a crystal we are dealing with the conditions of equilibrium between the growing crystal and the liquid in contact with it, and it is therefore a matter of primary importance to know all that can be ascertained about the latter.

Very little seems to be known at present about the nature of this liquid; that it is supersaturated is a reasonable supposition, but to what extent is not certain. The solution is being constantly impoverished by the growth of the crystal, although it is being constantly enriched by the influx of more saturated liquid.

Among the possible factors which determine the different vicinal faces succeeding each other during the growth of the crystal, it appeared from the experiments described above that differences in the degree of concentration of the liquid may conceivably play an important part; but in order to test this possibility it would be necessary to ascertain the composition of the liquid, not merely in the neighbourhood of the crystal, but actually in contact with it. Two methods of attacking the problem suggest themselves; although one cannot hope to analyse the layer of liquid

in contact with the crystal, it may be possible to measure either its specific gravity or its refractive index, and from these to determine the degree of concentration.

Now the goniometer used in the earlier part of this research lends itself admirably to the measurement of the refractive indices of solutions by the method of total reflection. If a glass prism be adjusted on the crystal holder, its angles and refractive index can be measured; it may then be immersed in the solution, and if we substitute for the square trough previously used a cylindrical trough (fig. 16, Plate 13)* with a plane glass front set perpendicular to the telescope, it will not be difficult to measure the angle of total internal reflection in the prism, and so the index of refraction of the liquid.

Further, by using a sufficiently small prism, the index of the liquid may be ascertained at any desired point, and by suspending a crystal in the solution and moving it gradually towards the surface of the prism, it may be possible to explore the liquid and to trace the change in refractive index as we approach the growing crystal.

A few observations were made in this way with a small glass prism of about 45° , and a crystal of alum immersed in concentrated solution in the square trough of fig. 1. A face of the crystal and the reflecting surface of the prism were accurately adjusted parallel to each other in the following way. The crystal was fixed for the purpose on a wire rod curved over the edge of the trough and mounted in a crystal holder provided with the ordinary tangent and traversing screws for centring and adjusting; the holder was clamped to a heavy stand placed beside the goniometer. The crystal was first adjusted until it reflected the image of the collimator slit upon the cross-wires of the telescope; it was then parallel to the axis of the goniometer. The crystal having been withdrawn to a short distance by the traversing screw, the prism was next adjusted so that its hypotenuse or totally reflecting surface also reflected the collimator signal on to the cross-wires. The prism being then turned through 180° had its reflecting surface parallel to and facing the crystal plane, and the crystal could be brought as close to it as is desired by means of the traversing screw. The telescope was next set at right angles to the second prism face, and then moved from this position through an angle equal to the angle of emergence for the saturated solution; the front of the trough being also moved so as to remain perpendicular to the telescope. Finally, therefore, the prism and telescope are in the approximate position for measuring the index of the liquid, and the crystal, having a face parallel to the reflecting surface of the prism, can be brought into absolute plane contact with it.

* The trough is a cylindrical vessel with truncated front; it is held in position by three spring clips, two of which press the plate of glass which constitutes the front against the ground edges of the vessel, and prevent leakage. The trough is adjusted upon its table by three levelling screws, and this table is fixed in any desired position upon the circular table of fig. 1 by means of two catches at the back and a clamping screw in front.

It was found that a perfectly definite reading being obtained with sodium light for total reflection—corresponding to the index of the saturated or slightly supersaturated solution—this reading was only slightly affected when the crystal was moved up and even brought into actual contact with the prism face. The index does actually increase to a certain small extent as the crystal is brought nearer to the prism, and this is shown by Nos. 1–4 in Table II., p. 500.

This indicates that the index of refraction only varies to a very slight extent, and therefore that the solution is only slightly supersaturated almost up to contact with the growing crystal.

It is clear, however, that this experiment does not really determine the index of the liquid in absolute contact with the crystal, whereas the ultimate layer is precisely that of which we require to know the composition, even if it be only a layer of inappreciable thickness. Is it not possible, however, to make use of the natural faces of the growing crystal as our totally reflecting prism? This, if feasible, appears to be in fact the only method of determining the refractive index of this ultimate layer of the liquid.

Preliminary experiments, in which the square glass trough and an octahedron of potash-alum were employed, presented considerable difficulties, but ultimately yielded a definite and clearly visible line of demarcation in the field of view, and showed that the method is a possible one.

Let $OA'O'B$ (fig. 17) be the outline of four faces of an octahedron of alum adjusted upon the goniometer, and growing in the solution; T being the telescope and C the collimator. The angle between the telescope and the collimator is first accurately

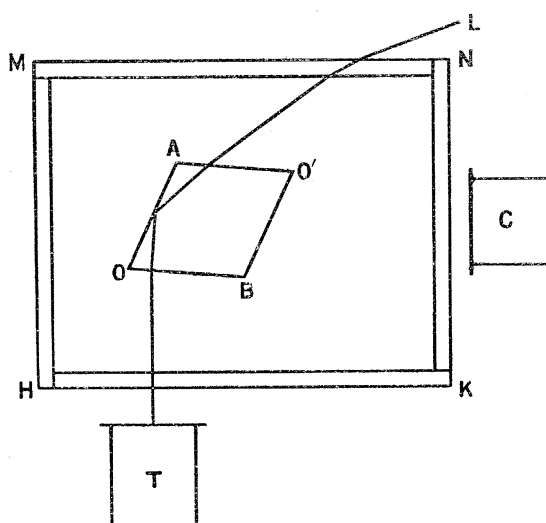

Fig. 17.

measured by means of a glass plate mounted on the crystal holder, being twice the angle θ between the position in which the glass plate reflects the collimator signal on to the cross-wires, and that in which the plate is perpendicular to the telescope as determined by the Gauss method. The front HK of the glass trough, $HKNM$, is then adjusted perpendicular to the telescope by the Gauss method, and the angle AOB is measured. A movable sodium flame at L is next adjusted by trial, and the crystal rotated, until the edge of the dark band indicating total internal reflection at OA is visible in the field of view and can be adjusted upon the vertical cross-wire.

Let the reading for this purpose be ϕ ; then, if β be the reading for which the image of the collimator signal is reflected upon the vertical wire from OB , and $\beta + \gamma$ the reading for which OB is perpendicular to T , then $\beta + \gamma - \phi = \theta$ is the angle of

emergence of the reflected light; *i.e.*, the angle between the rays entering the telescope from the crystal and the normal to the face OB.

If, then, A be the angle AOB, and n be the refractive index of the crystal, the refractive index, μ , of the liquid is given by the formula

$$\frac{\mu}{n} = \cos p; \quad \text{where} \quad \tan p = 2 \frac{\sin\left(45^\circ + \frac{A - \theta}{2}\right) \sin\left(45^\circ - \frac{A + \theta}{2}\right)}{\sin A}.$$

A preliminary experiment was made on November 14, 1900, with a good crystal of potash-alum growing at a temperature of 18.6° . The refractive index of the alum crystal for sodium light was measured in two ways: (1) by minimum deviation, using the octahedron as refracting prism; (2) by total internal reflection, making use of the natural faces of the crystal, and was found to be

1.4598 by minimum deviation, 1.4605 by total reflection.

The values previously found by STEFAN, GRAILICH, MULHEIMS, SORET, FOCK, and F. KOHLRAUSCH vary between 1.4549 and 1.4565.

The refractive index of a solution saturated at 18.6° was also determined in two ways: (1) by minimum deviation, using a hollow glass prism filled with the solution; (2) by total reflection, using a glass prism of refractive index 1.51704 immersed in the solution contained in the square trough, and pursuing the process described above.

It was found to be

1.34251 at 18° by total reflection, 1.34280 at 15° by minimum deviation

(the latter corresponding to 1.34250 at 18°).

With a prism of $70^\circ 31'$ formed by two octahedron faces, and with 1.4598 for the index of the crystal, and 1.3425 for the index of the liquid, the angle of emergence should be $\theta = 3^\circ 57' 36''$.

Of course one difficulty introduced by the use of the alum crystal itself is that the angle is not exactly that of the regular octahedron, and is liable to small variations. The faces, A, B, of the crystal used in this experiment did not give multiple images, and were inclined to one another at the angle $70^\circ 24'$. For this prism the angle of emergence should be $\theta = 3^\circ 50' 0''$.

The preliminary experiment gave a smaller angle of emergence, indicating a higher refractive index for the liquid, and showing that the solution in contact with the growing crystal is, in fact, supersaturated.

Before proceeding to determine the exact refractive index of the liquid, it was now necessary to ascertain (1) how the refractive index of strong solutions varies with their concentration; (2) whether there is any sudden change in the index in passing

from the saturated to a supersaturated solution; and (3) how the refractive index of supersaturated solutions varies with their strength. So far as I am aware, no previous observations have been made upon the refractive indices of supersaturated, or even of saturated, solutions of the substances investigated in this paper.

(B.) *The Refractive Indices of Supersaturated Solutions.*

The observations were made in two ways:—

- (1) By direct measurement of the minimum deviation in a hollow prism containing the solution;
- (2) By total reflection, by means of a glass prism of a known index immersed in the solution, using the new goniometer as described on p. 493.

With the minimum deviation method a supersaturated solution containing a known weight of salt to a known weight of water was taken, and a sample of about 6 cub. centims. introduced into the prism; the solution was then diluted with a measured volume of water and another sample examined, and so on. The temperature was measured by a thermometer inserted in the prism.

With the total reflection method it is easier than with the minimum deviation method to carry out a long series of observations upon solutions of slightly varying strength; for it is only necessary to add known volumes of water successively to a known solution. For example, 50 cub. centims. of a supersaturated solution of known strength having been placed in the glass trough, its refractive index was determined by the totally reflecting prism; 1 cub. centim. of water was then added and the index re-determined; this process was repeated until the trough was nearly full; a measured volume of the liquid was then removed from the trough, and the process was repeated and carried on until the solution was quite dilute. The liquid was, of course, kept constantly stirred during these experiments.

As regards the accuracy of the two methods, several examples will be found below of determinations of the same liquid by both; these always agree in the third place of decimals, and sometimes in the fourth.

As regards sensibility, an error of 1 minute in the reading for total reflection corresponds to about 2 in the fourth place of decimals, or to an error of about 2 minutes in the reading for minimum deviation.

Although the readings for total reflection cannot be made so accurately as those for minimum deviation, they could generally be relied upon to within 2 minutes, and sometimes to 1 minute.

Preliminary observations were first made upon solutions of alum and of tartaric acid, chiefly with the object of plotting the results upon a curve in order to ascertain whether there is any sudden change in the curvature, especially on passing from a

supersaturated to a saturated solution. In these experiments the constitution of the original saturated solution was not known, but that of the diluted solution at the close of the series was ascertained, and the former was approximately calculated from it.

(1.) *Refractive Indices of Solutions of Potash-alum.*

The refractive index of a saturated solution of potash-alum was approximately determined to be

1·34263 at 14° by total reflection, 1·34220 at $16^\circ\cdot 2$ by minimum deviation.

The following numbers represent the observations made by the total reflection method, with a prism of angle $44^\circ 58'$ and index 1·51704, upon 50 cub. centims. of a saturated solution of alum diluted down by successive additions of 1 cub. centim. of water (up to $\theta = 19^\circ 18'$), and then of 5 cub. centims. (up to $\theta = 19^\circ 8'$), and finally of 25 cub. centims.

TABLE I.—Series of Consecutive Determinations made by Method of Total Reflection.

 m = grammes of salt in 100 grammes of solution. μ = refractive index of solution. θ = angle of emergence.

No.	m .	θ .	μ .	t .	μ at 19°.
1	9·023	19 37½	1·34274	15°·1	1·3423
2	8·8509	19 35	1·34218	15·3	1·3418
3	8·6852	19 34½	1·34210	15·5	1·3417
4	8·5256	19 33¾	1·34199	15·6	1·3416
5	8·3718	19 32¼	1·34163	15·7	1·3413
6	8·2234	19 32	1·34156	15·9	1·3412
7	8·0802	19 31¼	1·34140	15·9	1·3411
8	7·9419	19 31¼	1·34140	16	1·3411
9	7·8082	19 30	1·34113	16·2	1·3408
10	7·6792	19 29½	1·34103	16·2	1·3407
11	7·5542	19 33½	1·34189	16·6	1·3416
12	7·4332	19 32	1·34156	17	1·3413
13	6·9854	19 30½	1·34124	17·1	1·3410
14	6·4964	19 27½	1·34060	17	1·3404
15	6·0714	19 24½	1·33995	17	1·3397
16	5·6986	19 23½	1·33973	17	1·3395
17	5·3689	19 22½	1·33952	17	1·3393
18	5·0753	19 20½	1·33909	17	1·3389
19	4·8121	19 19½	1·33887	17	1·3387
20	4·5748	19 18	1·33855	17	1·3383
21	4·1643	19 16	1·33812	17·2	1·3379
22	3·8213	19 14½	1·33779	17·3	1·3376
23	3·5306	19 12½	1·33736	17·2	1·3372
24	3·2809	19 12	1·33725	17·2	1·3370
25	3·0642	19 11½	1·33714	17·3	1·3369
26	2·8744	19 10½	1·33693	17·2	1·3367
27	2·7067	19 9½	1·33671	17·2	1·3365
28	2·5575	19 9½	1·33671	17·2	1·3365
29	2·4239	19 9	1·33660	17·2	1·3364
30	2·3036	19 8	1·33638	17	1·3362
31	1·5394	19 3½	1·33541	17	1·3352
32	1·1559	19 1½	1·33497	17	1·3348

The above observations are not represented on Diagram I.

Several determinations were made of the same solution at different temperatures, and indicated that the index is diminished by about $\cdot 0001$ for each degree of rise in temperature between the above temperatures. The fifth column gives the indices reduced to 19° .

The whole series can only be regarded as a somewhat crude first attempt to trace the changes of refractive index with the composition in strong solutions, and only with a view to the subsequent measurements made with a growing crystal. Samples of several of the liquids were measured at the same time by the hollow prism method in order to check the results.

No. 20 gave, at 17° , the values

1.33855 by total reflection, 1.33825 by minimum deviation.

No. 30 gave, at 17° ,

1.33638 by total reflection, 1.33623 by minimum deviation.

No. 32 gave, at 17° ,

1.33497 by total reflection, 1.33424 by minimum deviation.

The above results, plotted on a curve with m for abscissa and μ for ordinate (as in Diagram I.), give points which lie nearly upon a straight line, and indicate both that

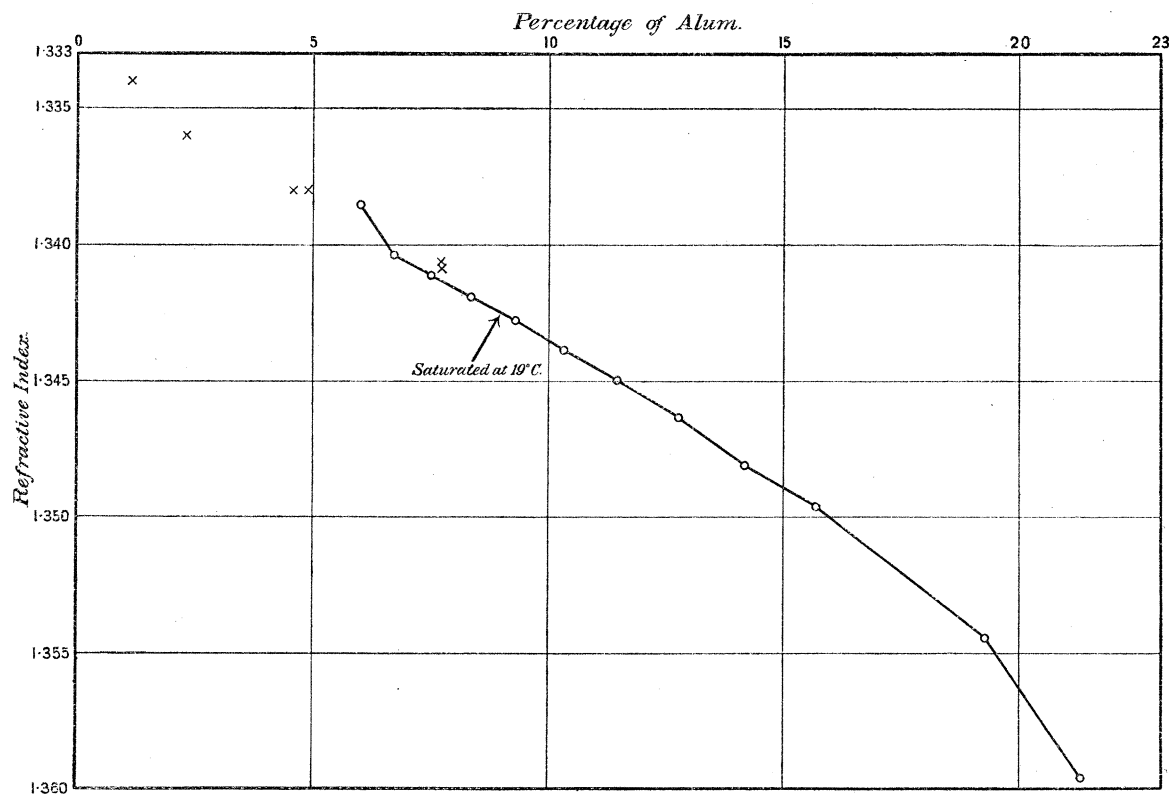

Diagram I.—Alum.

the total reflection method can be relied upon, and that there is no sudden break in the curve.

In this particular series there is a considerable dislocation of the curve between Nos. 10 and 11, due partly to the fact that the corner of the rectangular trough used in this experiment interfered with the illumination, and partly that, for fear of causing the liquid to crystallise, it was not efficiently stirred until this point was reached. For this reason the series is not plotted on Diagram I.

Table II. represents a series of isolated observations made by the method of total reflection upon saturated solutions at the ordinary temperature. In Nos. 1 to 4, which relate to the same solution, the temperature was not recorded; but the effect of approximation to crystals in the solution is here traced; No. 1 is a saturated solution; in No. 2 a few small crystals have been placed in the trough; in No. 3 a mounted crystal is brought near to the prism; in No. 4 it is brought almost into contact with the prism.

TABLE II.—Series of Isolated Determinations made by Method of Total Reflection.

No.	μ .	t .	μ at 19°.	Remarks.
1	1·34232	—	—	} Some alum crystals placed in the trough. A crystal face adjusted near prism. The crystal nearer to the prism. 16·6° is the air temperature.
2	1·34240	—	—	
3	1·34306	—	—	
4	1·34350	—	—	
5	1·34273	16·6	1·34250	—
6	1·34251	—	—	—
7	1·34326	15	1·34286	—
8	1·34433	15	1·34396	Prism immersed deep in trough.
9	1·34274	15	1·34234	—
10	1·34210	—	—	} Same solution (two determinations).
11	1·34199	—	—	
12	1·34263	14½	1·34210	Some crystals in trough.

All these are solutions saturated, or very slightly supersaturated, at the ordinary temperature; but the observations are not represented on Diagram I. because the exact composition of the several solutions is not certain.

Table III. represents a series of observations made upon a supersaturated solution of known strength gradually diluted down by addition of water, and determined by means of a hollow prism holding about 6 cub. centims. of liquid.

These are denoted by small circles on Diagram I., and serve to establish approximately a curve which shows the relation between composition and refractive index in supersaturated and strong solutions of potash alum.

Table IV. represents a few isolated observations made by the hollow prism upon solutions of known strength; they are denoted by small crosses on Diagram I., and serve to check the curve represented in Table III.

TABLE III.

No.	m .	μ .	t .
1	21·253	1·35961	19°
2	19·226	1·35439	19
3	15·667	1·34957	19
4	14·134	1·34806	19
5	12·729	1·34627	19
6	11·455	1·34497	19
7	10·298	1·34388	19
8	9·268	1·34274	19
9	8·321	1·34192	19
10	7·466	1·34111	19
11	6·696	1·34035	19
12	6·003	1·33850	19

The above observations are represented by circles on Diagram I.

TABLE IV.—Isolated Determinations made by Method of Minimum Deviation.

No.	m .	μ .	t .	μ at 19°.
1	7·7198	1·34083	19°	1·34083
2	7·7339	1·34088	16½	1·3406
3	4·897	1·33817	18	1·3381
4	4·575	1·33825	17	1·3380
5	2·304	1·33622	17	1·3360
6	1·156	1·33424	15½	1·3340

The above observations are represented by crosses on Diagram I.

(2.) *Refractive Indices of Solutions of Tartaric Acid.*

The refractive index and composition of a saturated solution of tartaric acid were determined as follows :—

m = grammes of substance in 100 grammes of solution.

μ = refractive index.

m .	μ .	t .	
58·489	1·41672	19°	By minimum deviation.
58·489	1·41667	20	
?	1·41649	19	

Strongly supersaturated solutions of unknown constitution were next examined by the total reflection method with the prism of angle $44^{\circ} 58'$ and index 1.51704.

In Series I., 50 cub. centims. of a supersaturated solution S_1 were placed in the trough and diluted by successive additions of 2 cub. centims. of water. The results are given in Table V., and are represented by dots in Diagram II.

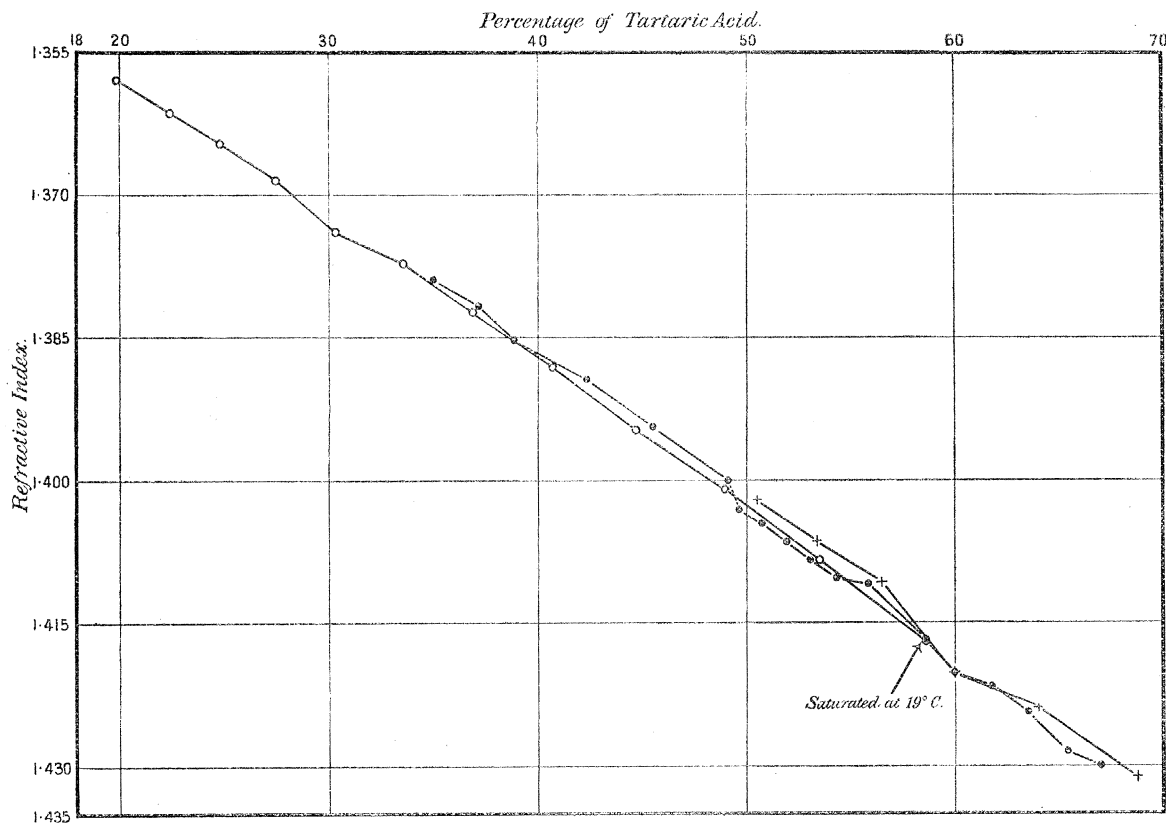

Diagram II.—Tartaric Acid.

The strength of these solutions is obtained by assuming that No. 6 has the same constitution as No. 1 in Table VIII., which possesses practically the same refractive index, *i.e.*, that 50 cub. centims. weigh 64.94 grammes and contain 37.983 grammes of the substance.

50 cub. centims. of the solution S_1 were diluted with 25 cub. centims. of water; and 50 cub. centims. of this new solution (Σ) were then examined in the trough and diluted by successive additions of 5 cub. centims. of water. The results are given in Table VI., and are represented by dots in Diagram II.: this set should, of course, be continuous with the preceding; they are connected by a dotted line on the diagram.

In Series II., 50 cub. centims. of a supersaturated solution S_2 were diluted by successive additions of 5 cub. centims. of water. The results are given in Table VII., and are represented by crosses in Diagram II.

The strength of these solutions is obtained by assuming that No. 3 has the same constitution as No. 5 in Table V., the two having nearly the same refractive index.

TABLE V.—Series of Consecutive Determinations made by Method of Total Reflection.

Tartaric Acid, Solution S_1 .

No.	m .	θ .	μ .	t .	μ at 19° .
1	67·10	27 16	1·43065	16·8	1·4302
2	65·18	27 5	1·42883	17·8	1·4286
3	63·37	26 40	1·42464	18·5	1·4245
4	61·65	26 23	1·42174	19	1·4217
5	60·03	26 13	1·42002	19·3	1·4200
6	58·489	25 55	1·41690	19·5	1·4169
7	55·63	25 20	1·41069	19·6	1·4108
8	54·31	25 16	1·40997	19·6	1·4101
9	53·04	25 6	1·40816	19·6	1·4083
		25 3	1·40762	19·2	1·4077
10	51·84	24 56	1·40634	19·2	1·4064
11	50·68	24 46	1·40451	19	1·4045
12	49·58	24 38	1·40304	19	1·4030

TABLE VI.—Series of Consecutive Determinations made by Method of Total Reflection.

Tartaric Acid, Solution Σ .50 cub. centims. of the solution (50 cub. centims. S_1 + 25 cub. centims. water).

No.	m .	θ .	μ .	t .	μ at 19° .
13	49·05	24 22	1·40007	17·2	1·4000
14	45·39	23 55	1·39498	16	1·3944
15	42·23	23 29	1·39002	16·4	1·3895
16	38·71	23 8	1·38595	16·6	1·3854
17	37·08	22 49	1·38222	16·8	1·3818
18	34·94	22 35	1·37945	17	1·3790

TABLE VII.—Series of Consecutive Determinations made by Method of Total Reflection.

Tartaric Acid, Solution S_2 .

No.	m .	θ .	μ .	t .	μ at 19° .
1	68·78	27 23	1·43176	16·6	1·4312
2	64·11	26 37	1·42413	18	1·4239
3	60·03	25 57	1·41724	18·3	1·4171
4	56·43	25 22	1·41105	18·5	1·4110
5	53·25	24 57	1·40653	18·7	1·4065
6	50·40	24 33	1·40211	18·7	1·4021

Table VIII. represents a series of observations made upon a solution of known strength gradually diluted down by addition of water and determined by means of the hollow prism, as in the case of alum. These are represented by small circles on Diagram II. and serve, as before, to establish approximately a curve showing the relation between composition and refractive index in supersaturated and strong solutions of tartaric acid.

TABLE VIII.—Series of Consecutive Determinations made by Method of Minimum Deviation.

No.	m .	μ .	t .
1	58·489	1·41672	19°
2	53·542	1·40843	19
3	48·908	1·40092	19
4	44·588	1·39459	19
5	40·573	1·38817	19
6	36·856	1·38247	19
7	33·427	1·37728	19
8	30·272	1·37292	19
9	27·377	1·36860	19
10	24·729	1·36470	19
11	22·312	1·36149	19
12	19·842	1·35789	19

(3.) *Refractive Indices of Solutions of Sodium Chlorate.*

The refractive index of a saturated solution of sodium chlorate was found as follows :—

μ .	t .	
1·38754	16°·2	By total reflection.
1·38634	19	By minimum deviation.

Supersaturated and strong solutions were next examined by the total reflection method, as in the preceding examples.

In Series I., 20 cub. centims. of a solution containing 13·141 grammes of sodium chlorate were placed in the trough and examined with a totally reflecting prism of angle 44° 51', and index 1·51704, and diluted down by successive additions of 2 cub. centims. of water. The results are given in Table IX., and are represented by dots in Diagram III.

In Series II., 10 cub. centims. of a supersaturated solution containing 8·026 grammes

THE VARIATION OF ANGLES OBSERVED IN CRYSTALS.

505

of sodium chlorate were diluted with successive additions of 4 or 2 cub. centims. of water (warm water being used at first). The results are given in Table X., and are represented by crosses in Diagram II.

TABLE IX.—Series of Consecutive Determinations made by Method of Total Reflection.

No.	<i>m.</i>	θ .	μ .	<i>t.</i>	μ at 19°.
1	46·902	23 16	1·38599	20	1·3862
2	43·780	22 51½	1·38117	20	1·3814
3	41·045	22 38	1·37850	20	1·3787
4	38·632	22 22	1·37530	20	1·3755
5	36·486	22 11	1·37309	20	1·3733
6	34·567	21 59	1·37065	20	1·3708
7	32·839	21 48	1·36841	20½	1·3687
8	31·276	21 39½	1·36668	20¾	1·3670
9	29·855	21 31½	1·36503	20¾	1·3653
10	28·558	21 24	1·36349	21	1·3639
11	27·368	21 17½	1·36215	21	1·3625
12	26·273	21 11	1·36080	21	1·3612
13	25·263	21 6	1·35976	21	1·3602
14	24·328	21 0	1·35851	21	1·3589
15	23·459	20 56	1·35768	21	1·3581
16	21·896	20 47½	1·35590	21	1·3563
17	19·906	20 38	1·35390	21	1·3543

TABLE X.—Series of Consecutive Determinations made by Method of Total Reflection.

No.	<i>m.</i>	θ .	μ .	<i>t.</i>	μ at 19°.
1	55·432	24 5	1·39542	29	1·3974
2	43·432	22 47	1·38029	26	1·3817
3	39·191	22 23	1·37550	25½	1·3768
4	35·704	22 8	1·37247	21½	1·3730
5	32·787	21 52	1·36923	20½	1·3693
6	30·310	21 37½	1·36626	20	1·3665
7	28·182	21 25½	1·36380	19½	1·3639
8	26·333	21 16	1·36184	19½	1·3619
9	24·711	21 5½	1·35966	19¼	1·3597
10	22·002	20 52½	1·35695	19	1·3569
11	19·828	20 40	1·35432	19	1·3543
12	18·044	20 30	1·35222	19	1·3522

Table XI. represents a series of observations made by means of the hollow prism upon 25 cub. centims. of a solution of sodium chlorate concentrated at 19° and diluted

by successive additions of 6 cub. centims. of water; the results are represented by small circles upon Diagram III.

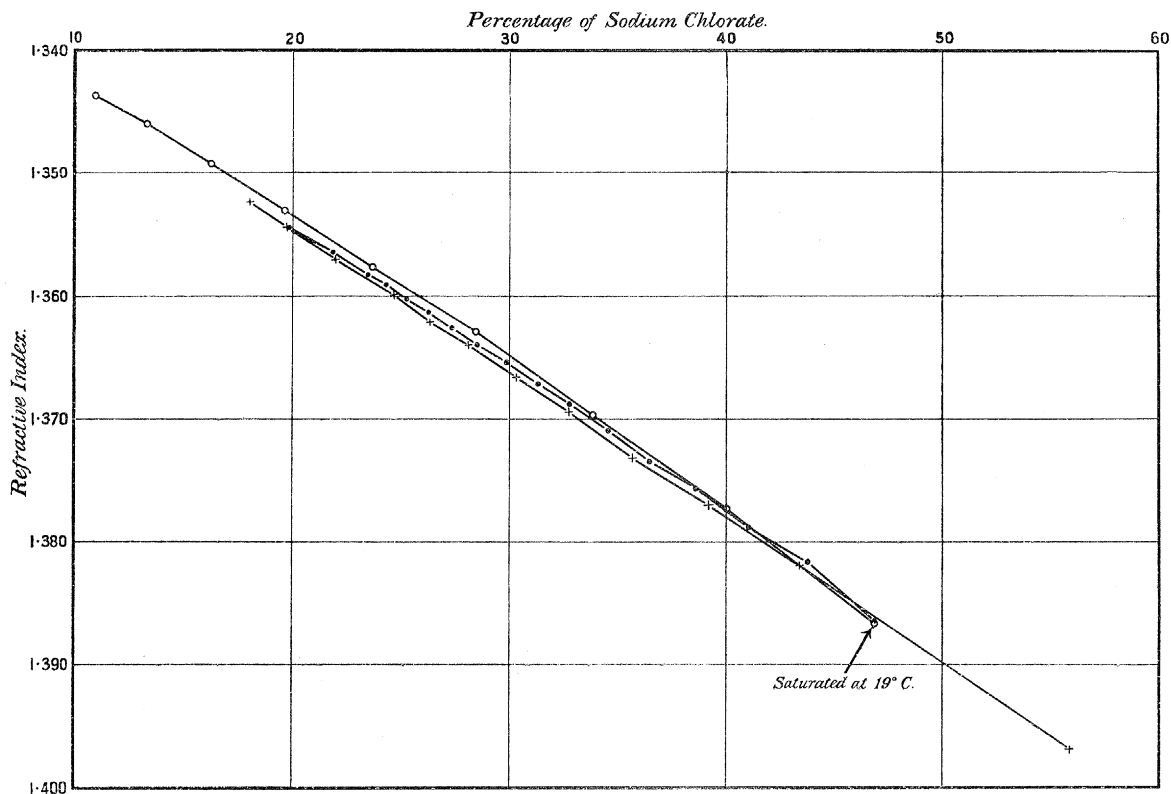

Diagram III.—Sodium Chlorate.

The constitution of the solutions of Table XI. is fixed by assuming that No. 1 has the same constitution as No. 1 of Table IX., which was also a saturated solution, and has nearly the same refractive index.

TABLE XI.—Series of Consecutive Determinations made by Method of Minimum Deviation.

No.	m .	μ .	t .
1	46.902	1.38634	19
2	40.044	1.37711	19
3	33.90	1.36953	19
4	28.47	1.36283	19
5	23.75	1.35756	19
6	19.70	1.35287	19
7	16.27	1.34909	19
8	13.33	1.34594	19
9	10.96	1.34361	19

(4.) *Refractive Indices of Solutions of Sodium Nitrate.*

The refractive index of a saturated solution of sodium nitrate was found as follows:—

μ .	t .	
1·38880	$19\frac{3}{4}$	By minimum deviation.
1·38837	22	" " "
1·38770	24·5	" " "
1·38873	17·5	„ total reflection.

Supersaturated and strong solutions were next examined by the total reflection method (prism of $44^{\circ} 52'$, index 1·51704). In Series I., 20 cub. centims. of a saturated solution were placed in the trough and examined with the same totally reflecting prism as before, and were diluted by successive additions of 2 cub. centims. of water up to No. 15. Nos. 16 and 17 were taken after addition of 6 cub. centims. and 4 cub. centims. of water respectively. In this series Nos. 1 and 2 were taken on one day and the remainder on the following day. The results are given in Table XII. and are represented by crosses in Diagram IV.

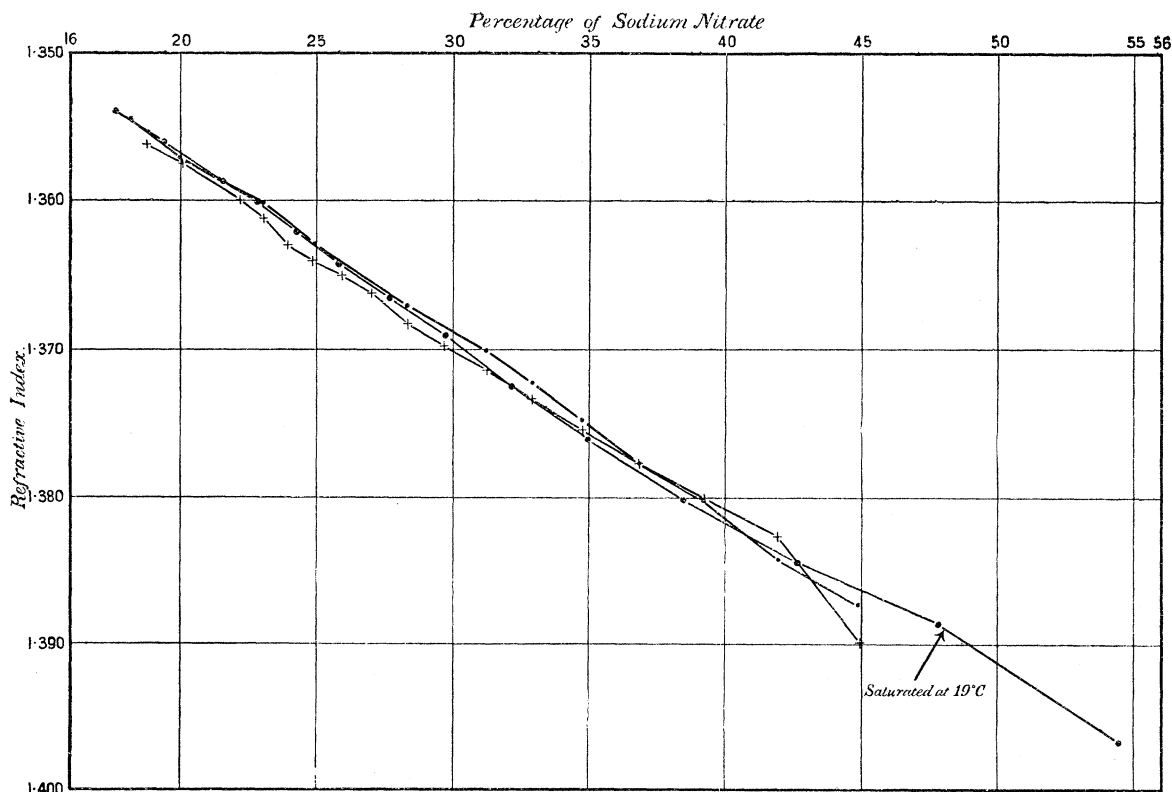

Diagram IV.—Sodium Nitrate.

In Series II., 20 cub. centims. of a saturated solution were examined and diluted down by successive additions of 2, 4, 6, or 8 cub. centims. of water. This series of observations was made in a single day. The results are given in Table XIII. and are represented by dots in Diagram IV.

In Series III., 10 cub. centims. of a supersaturated solution, weighing 14.39 grammes and containing 7.843 grammes of substance, were placed in the trough and diluted by successive additions of 2 cub. centims. of water up to No. 12; warm water being used up to No. 5; water at the ordinary temperature from No. 6 onwards; Nos. 13 and 14 were made after the addition of 4 cub. centims. each.

The results are given in Table XIV. and are represented by dots in Diagram IV.

The irregularity in the series of crosses is fully accounted for by the break in the continuity of the observations.

TABLE XII.—Series of Consecutive Determinations made by the Method of Total Reflection.

No.	<i>m.</i>	<i>θ.</i>	<i>μ.</i>	<i>t.</i>	<i>μ</i> at 19°.
1	45.001	23 33	1.38950	20½	1.3899
2	41.920	22 52	1.38150	20½	1.3826
3	39.235	22 48	1.38070	18½	1.3806
4	36.873	22 33	1.37772	18½	1.3776
5	34.779	22 20½	1.37522	19½	1.3754
6	32.910	22 10	1.37311	20	1.3733
7	31.232	21 59	1.37093	20½	1.3714
8	29.717	21 51	1.36926	20½	1.3697
9	28.342	21 43½	1.36773	20¾	1.3683
10	27.088	21 33½	1.36568	21	1.3662
11	25.941	21 27½	1.36445	21	1.3650
12	24.887	21 22	1.36331	21¼	1.3640
13	23.915	21 16½	1.36217	21¼	1.3629
14	23.016	21 8	1.36041	21¼	1.3611
15	22.182	21 2½	1.35927	21¼	1.3599
16	20.008	20 50½	1.35676	21¼	1.3574
17	18.781	20 44	1.35540	21¼	1.3561

The above observations are represented by crosses in Diagram IV.

TABLE XIII.—Series of Consecutive Determinations made by the Method of Total Reflection.

No.	m .	θ .	μ .	t .	μ at 19° .
1	45·037	$23 \frac{2}{2}$	1·38716	$18^\circ 2$	1·38706
2	41·949	$23 \frac{7}{2}$	1·38433	18	1·3840
3	39·258	22 51	1·38108	18	1·3808
4	36·891	$22 \frac{34}{2}$	1·37780	18	1·3775
5	34·793	$22 \frac{20}{2}$	1·37500	18	1·3747
6	32·922	22 9	1·37268	18	1·3724
7	31·242	22 0	1·37086	18	1·3706
8	28·347	21 42	1·36719	18	1·3669
9	24·888	$21 \frac{22}{2}$	1·36317	18	1·3629
10	23·016	21 11	1·36080	$18 \frac{1}{4}$	1·3606
11	21·406	21 1	1·35872	$18 \frac{1}{4}$	1·3585
12	20·006	20 54	1·35726	$18 \frac{1}{4}$	1·3570
13	18·219	20 45	1·35538	$18 \frac{1}{2}$	1·3544

The above observations are represented by dots in Diagram IV.

TABLE XIV.—Series of Consecutive Determinations made by the Method of Total Reflection.

No.	m .	θ .	μ .	t .	μ at 19° .
1	54·506	$23 \frac{5}{4}$	1·39332	30°	1·3966
2	47·855	23 10	1·38482	$31 \frac{1}{2}$	1·3885
3	42·650	22 47	1·38029	$32 \frac{1}{2}$	1·3843
4	38·467	22 27	1·37630	$32 \frac{1}{2}$	1·3803
5	35·031	22 15	1·37389	26	1·3760
6	32·158	$22 \frac{1}{2}$	1·37116	$23 \frac{1}{4}$	1·3724
7	29·721	21 45	1·36780	23	1·3690
8	27·627	$21 \frac{34}{2}$	1·36565	22	1·3665
9	25·809	21 23	1·36328	22	1·3642
10	24·212	21 13	1·36121	$21 \frac{3}{4}$	1·3620
11	22·807	21 7	1·35997	19	1·3600
12	21·554	21 1	1·35872	19	1·3587
13	19·419	20 48	1·35600	19	1·3560
14	17·669	20 38	1·35391	19	1·3539

The above observations are represented by dots in Diagram IV.

All the above experiments indicate that the composition of a supersaturated, a saturated, or a strong solution may be ascertained with a certain degree of accuracy by determining the refractive index by means of a totally reflecting prism; there

appears to be no sudden break in the curvature of the curve which expresses the relation between refractive index and constitution.

They must not be regarded as more than a first attempt to establish this fact and to determine the curve for four substances: in the case of the supersaturated solutions, the stirring was not always satisfactory, on account of the danger of making the solution crystallise; and in the same series of observations the constitution was only deduced by comparison with another series. However, the very fair coincidence between the determinations made quite independently by the two methods gives some confidence in the experiments next to be described, in which a growing crystal itself is employed as the totally reflecting prism.

(C.) *The Refractive Index and Concentration of the Solution in Contact with Growing Crystals of Alum, Sodium Chlorate, and Sodium Nitrate.*

As explained above, the growing crystal itself may in some instances be used as the totally reflecting prism, and it will then give the refractive index of the solution in contact with the crystal by the formula on p. 495. Some difficulty will, of course, be experienced by reason of the vicinal faces; in the first place, the angle of the prism will have to be measured during, or immediately after, each observation; this can be done without withdrawing the crystal from the solution if the square trough be employed; in the second place, and this is a more serious difficulty, the prism faces are no longer single plane surfaces, but sets of vicinal faces, and it will be necessary to select such as are very flat, or to make use of the growing crystal at the precise moment when two large vicinal faces can be employed as a prism and the rest are sufficiently small to be ignored. In spite of these difficulties, observations have

been made upon the two cubic substances, alum and sodium chlorate, and upon sodium nitrate, which serve to determine approximately the refractive index of the liquid, and therefore, by the help of the preceding diagrams, its constitution.

Since the light, on emerging from the crystal, traverses a liquid of varying density, and since the crystal face through which it emerges is not parallel to the side AB of the trough nearest to the telescope T, the formula on p. 495 is not rigidly applicable (see fig. 18).

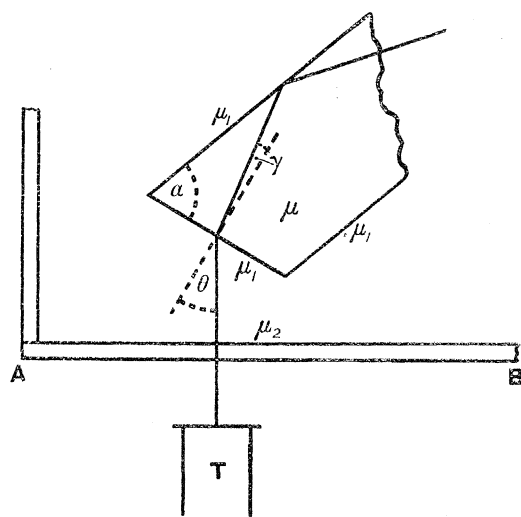

Fig. 18.

with it, and μ_2 the index of a saturated solution, which is known from the preceding

experiments, then the light after emergence traverses a liquid whose index changes from μ_1 to μ_2 ; and, if it be assumed that it changes uniformly, then the index μ_1 can be deduced from the angle of emergence θ and the angle of the crystal α by the formula

$$\mu_1 = \mu \cos \left[\cos^{-1} \frac{\mu_2 \sin \theta}{\mu} - \alpha \right].$$

Under the conditions described below, this formula is practically identical with that given on p. 495.

(1.) *Potash-alum.*

With alum either the acute or the obtuse angle of the octahedron may be employed, and, therefore, a theoretically perfect crystal would admit of four determinations without readjustment, using in turn the four octahedron faces as the totally reflecting surface. In general it was not possible to carry out more than one determination on each crystal in consequence either of vicinal faces, or the difficulty of illumination owing to the shape of the crystal, or the imperfections of the faces. A very perfect crystal giving single reflections from two faces B and C was adjusted, and immersed in concentrated solution one evening and allowed to grow during the night; on the following day no reading could be obtained, but on the second day a reading was obtained for total reflection at C, the light emerging through D (fig. 19).

Assuming that the angle α is $109^\circ 29'$, and calculating from the reading for which C was perpendicular to the telescope (D itself being a somewhat unsatisfactory face), the angle of emergence, θ , was found to be $-46^\circ 54\frac{1}{2}'$. Taking the value 1.4598 for the index of the alum, this leads to the value 1.3455 for the index of the liquid in contact with C, and, therefore, indicates that the liquid is only slightly supersaturated.

If the index of the liquid had been 1.34232, the value found for the saturated solution, the angle of emergence would be $-47^\circ 26'$, a difference lying far beyond the errors of observation.

If the angle of the prism was $109^\circ 23\frac{1}{2}'$, as deduced from the measured angle BC, instead of the theoretical angle $109^\circ 29'$, the angle of emergence would have been $-46^\circ 49'$, indicating that the difference observed cannot be attributed to a small error in the angle of the crystal.

The crystal was re-examined in the evening, and, immediately after the reading for total reflection had been taken, the crystal was dried with a soft tongue of blotting paper and re-measured. The faces CD yielded (in addition to other

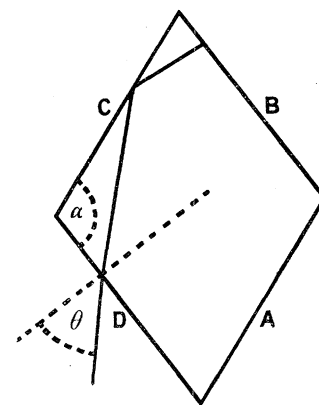

Fig. 19.

images) two bright images corresponding to faces inclined to each other at $109^{\circ} 6'$; and the angle of emergence through D was $-46^{\circ} 51'$. This gives the index as 1.34312.

A third determination was made with the same crystal on the following day, using the acute angle of the octahedron as prism, *i.e.*, total reflection taking place at B and emergence through C.

This gave $BC = 70^{\circ} 43'$ and the angle of emergence $\theta = -4^{\circ} 16'$, leading to the value 1.34171 for the index of the liquid; in this case, however, the crystal was probably not growing, but was in contact with a diluted liquid, for the line of total reflection was not well defined, the addition of a little water did not affect the reading, and etched triangles made their appearance on the faces. The value 1.34171 is simply the index of an almost saturated solution. Another crystal was mounted and examined in the same way with the obtuse angle for prism; this gave

$$\alpha = 109^{\circ} 39\frac{1}{2}', \quad \theta = -47^{\circ} 19\frac{1}{2}', \quad \mu = 1.34422.$$

The same crystal, examined on the following day at $14\frac{1}{2}^{\circ}$, gave

$$\alpha = 109^{\circ} 30\frac{1}{2}', \quad \theta = -47^{\circ} 19\frac{1}{2}', \quad \mu = 1.34313.$$

But the faces now yielded triple images, so that this determination is possibly not so reliable as the preceding one.

The crystal was then withdrawn and the glass prism inserted in place of it; this gave

$$\alpha = 44^{\circ} 58', \quad \theta = 19^{\circ} 37', \quad \mu = 1.34263.$$

The above observations are sufficient, I think, to establish conclusively that the liquid in contact with a growing crystal of alum is slightly supersaturated, and that its index differs by about .0007 from that of a saturated solution at the same temperature. Other observations led to the same result.

The mean of the best determinations for the solution in contact with a growing crystal at 14° ,

$$1.34375, 1.34331, 1.34343, 1.34308, 1.34330, 1.34332, 1.34313 \text{ is } \mu = 1.34336.$$

The best determination for the saturated solution at 14° gave

$$\mu = 1.34263.$$

Interpreting these results by the curve of Diagram I, we arrive at the conclusion that at 14° C. :—

- (1) A saturated solution of potash-alum contains about 8·5 grammes of the substance in 100 grammes of solution ;
- (2) The liquid in contact with a growing crystal contains about 9·3 grammes of the substance in 100 grammes of the solution.

Specific Gravity of Solution in Contact with a Growing Crystal of Potash-alum.

The refractive index of the liquid in contact with a growing crystal having been determined, it seemed desirable to determine also its specific gravity.

A solution was therefore made containing 9·3 grammes of K-alum per 100 grammes of solution, and the following observations were made :—

Temperature.	Specific gravity.
14°	1·0458 referred to water at 14° C.

This agrees very closely with the value obtained by constructing a curve from the values found by GERLACH and quoted by LANDOLT and BÖRNSTEIN, 'Physikalisch-Chemische Tabellen,' 1894, p. 203.

The refractive index of this solution was determined by the method of total reflection with a glass prism of $60^{\circ} 10\frac{1}{2}'$, and refractive index 1·62151, immersed in the liquid. The value obtained was :—

At 14° 1·34310.

The index, as determined from the curve of Diagram I., would be 1·34336 at 14° C.

(2.) *Sodium Chlorate.*

Sodium chlorate has a refractive index of 1·5151 for sodium light, according to KOHLRAUSCH, and we have already found that the index of a saturated solution of the substance at 16° is about 1·38754 ; with these values, and using cube faces for the surfaces of the reflection and emergence, *i.e.*, using a prism of angle 90° , the angle of total reflection should be $23^{\circ} 40\frac{3}{4}'$, and the angle of emergence $26^{\circ} 0\frac{1}{2}'$.

A fairly good cube of sodium chlorate growing in its solution yielded readings for total reflection from each of the four cube faces in one zone ; the best of these corresponded to the angle of emergence $\theta = - 26^{\circ} 5'$.

Assuming the angle α to be 90° , and taking the value 1·5151 for the index of the crystal, we get $\mu = 1·3870$ for the index of the liquid in contact with the crystal.

A second crystal gave $\theta = - 25^{\circ} 56'$, $\alpha = 89^{\circ} 59'$, and, therefore, $\mu = 1·38801$.

A third crystal gave the following very good readings at 15° , the observations being made late at night when the crystal was growing steadily and uniformly.

Readings for the images of the collimator signal reflected from the four cube faces A, B, C, D:—

$$\left[\begin{array}{l} A_a \ 163^\circ \ 39\frac{1}{2}', \\ A_\beta \ 163^\circ \ 28', \\ B \ 73^\circ \ 33', \\ C_a \ 343^\circ \ 38', \\ C_\beta \ 343^\circ \ 28', \\ D \ 253^\circ \ 33'. \end{array} \right.$$

As explained on p. 484, the faces A, C yield each two images lying in a horizontal plane, and the faces B, D two images lying in a vertical plane.

The readings for total reflection were:—

$$\begin{array}{llll} 233^\circ \ 54' & \text{light reflected at B emerging through A.} & & \\ 143^\circ \ 48\frac{1}{2}' & \text{,, ,, C ,, ,, B,} & & \\ 53^\circ \ 56\frac{1}{2}' & \text{,, ,, D ,, ,, C.} & & \end{array}$$

The angle between telescope and collimator was $88^\circ \ 42'$.

On the following morning almost precisely the same readings were obtained. There is clearly here a difficulty in deciding what to take as the value of the angle α .

Confining our attention to the case in which total reflection takes place at the face B, and taking in succession the maximum value $A_a B = 90^\circ \ 6\frac{1}{2}'$, the minimum value $A_\beta B = 89^\circ \ 55'$, and the mean value $AB = 90^\circ \ 0'$, the three results are:—

$$\begin{array}{lll} \alpha = 90^\circ \ 6\frac{1}{2}', & \theta = -25^\circ \ 53', & \mu = 1.38951 \text{ at } 16^\circ. \\ \alpha = 89^\circ \ 55', & \theta = -26^\circ \ 4\frac{1}{2}', & \mu = 1.38630 \text{ ,, } 16^\circ. \\ \alpha = 90^\circ \ 0', & \theta = -26^\circ \ 0', & \mu = 1.38767 \text{ ,, } 16^\circ. \end{array}$$

Finally, then, we have for the refractive index of the liquid in contact with a growing crystal of sodium chlorate at 16° , $\mu = 1.38794$ about.

Interpreting these results by the curve of Diagram III. we arrive at the conclusion that at 16° C :—

- (1) A saturated solution of sodium chlorate contains about 47.36 grammes of the substance in 100 grammes of solution ;
- (2) The liquid in contact with a growing crystal contains about 47.73 grammes of the substance in 100 grammes of solution.

(3.) *Sodium Nitrate.*

The preceding observations relate to isotropic substances; it appeared advisable to apply the same method to some substance not belonging to the cubic system and possessing strong double refraction. Sodium nitrate lends itself admirably to this purpose and both cleaves and crystallises readily in the form of rhombohedra of $73^{\circ} 30'$. The refractive index of a saturated solution of sodium nitrate was determined above to be about 1.38905 at 19° (mean of 1.38850, 1.38913, 1.38927, 1.38930). With a prism of $73^{\circ} 30'$ this would give for a cleavage rhomb of sodium nitrate in contact with a saturated solution an angle of total reflection of $28^{\circ} 57'$ and an angle of emergence of $-14^{\circ} 15\frac{3}{4}'$, taking $\omega = 1.58739$, and using only the ordinary index (see fig. 20).

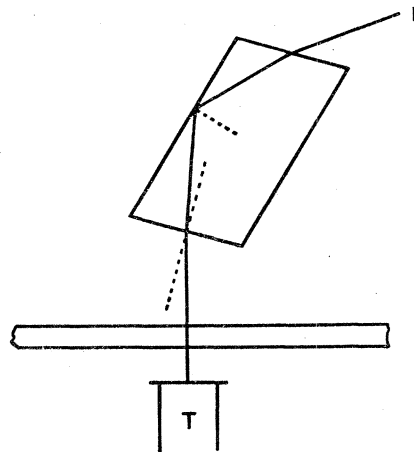

Fig. 20.

A cleavage crystal having an angle of $73^{\circ} 35'$ between two very good faces was immersed in saturated solution and gave an angle of emergence of $\theta = -14^{\circ} 11'$. This leads to the value 1.39085 for the refractive index of the liquid.

Another cleavage fragment gave

$$\alpha = 73^{\circ} 34', \quad \theta = -14^{\circ} 17\frac{1}{2}', \quad \mu = 1.38954 \text{ at } 17\frac{1}{2}^{\circ}.$$

A third cleavage fragment immersed in a saturated solution kept at about the same temperature by surrounding the trough with beakers of ice gave

$$\alpha = 73^{\circ} 33', \quad \theta = -14^{\circ} 15\frac{1}{2}', \quad \mu = 1.38968.$$

A fourth, for which the solution was cooled down to 16° by the same method, gave

$$\alpha = 73^{\circ} 35', \quad \theta = -14^{\circ} 12', \quad \mu = 1.39067, \quad t = 16^{\circ}.$$

A fifth gave

$$\alpha = 73^{\circ} 35', \quad \theta = -14^{\circ} 13\frac{1}{2}', \quad \mu = 1.39042, \quad t = 17\frac{1}{2}^{\circ}.$$

Finally, then, we have for the refractive index of the liquid in contact with a growing crystal of sodium nitrate (mean of 1.38954 and 1.39042), $\mu = 1.38998$ at $17\frac{1}{2}^{\circ}$.

Interpreting these results by the curve of Diagram IV. we arrive at the conclusion that at $17\frac{1}{2}^{\circ}$ C:—

- (1) A saturated solution of sodium nitrate contains about 47.65 grammes of the substance in 100 grammes of the solution;
- (2) The liquid in contact with a growing crystal contains about 48.8 grammes of the substance in 100 grammes of the solution.

It must be remarked that owing to the use of cleavage fragments in these experiments it is not absolutely certain in every case that the crystal was actually growing, and it is possible that the higher values are the most correct.

It will be noticed that the refractive index of a saturated solution of sodium nitrate is greater than the extraordinary index, 1.33608, of the crystallised substance, and less than the ordinary index, 1.58739, so that only the ordinary index comes into operation in these experiments, and with regard to the index of the crystal no account need be taken of the direction in which the light is travelling in the crystal.

With all the three substances examined the result is the same: the liquid in contact with a growing crystal is slightly, and only slightly, supersaturated.

PART III.

THE ACTION OF THE CONCENTRATION STREAMS (CRYSTALLISATION IN MOTION).

Interpretation of the Foregoing Results. A Possible Cause for the Variation of Angle in Alum and other Crystals.

In the preceding pages we have seen that, in the case of alum, the apparent variation of the octahedron angle is certainly due to the production of vicinal faces, and that the same cause is probably sufficient to account for the variations of angles in the forms of other substances. The variations are small, but they lead to the following important results:—

The faces which actually occur upon a crystal are, in general, not those with simple rational indices, but are vicinal faces.

It is true that these probably possess rational indices, but such as can only be expressed by high numbers.

To what are these faces to be attributed?

There is little in crystallographic literature which throws light upon the subject, and, so far as I am aware, absolutely no experimental work.

Only in the recent remarkable and original investigations of G. WULFF, upon the velocity of crystal growth, is a definite explanation of the vicinal faces proposed.*

WULFF finds that the velocity of outward growth of a crystal is different for different faces, and he supposes that it is probably inversely proportional to their reticular density; the actual velocity of growth is, however, largely influenced by the intensity and direction of the concentration streams which flow upwards round the crystal. Experiments upon these led him to the conclusion that the crystals grow

* “Zur Frage der Geschwindigkeit des Wachstums und der Auflösung der Krystallflächen,” ‘Zeitsch. f. Kryst.,’ 1901, vol. 34, p. 449.

most regularly when the concentration streams are weakest. In order to eliminate the effect of the concentration streams, his crystals were made to grow in rotating vessels, and very uniform results were obtained. WULFF points out that those faces which grow outwards most slowly increase in area at the expense of those which grow most rapidly, so that the latter are soon eliminated; the actual forms occurring on a crystal are, therefore, those whose rate of growth is least, and these are the faces of greatest reticular density.

The substance used by WULFF in his experiments was ferrous-ammonium sulphate.

In an investigation by Z. WEYBERG* the experiments were extended to iron-ammonium-alum, and led to the result that crystals of this substance grow in an aqueous solution, with a supersaturation of about 2 per cent., and at a temperature of 8° C., twice as fast in a direction perpendicular to the dodecahedron faces as perpendicular to the cube faces, and from three to four times more rapidly perpendicular to the cube than to the octahedron.

According to WULFF, therefore, the usual planes on a crystal must be those of high reticular density, and the vicinal planes must be exceptional and due to some disturbing cause, which he describes as follows:—

“ Die Concentrationsströmungen verursachen das Erscheinen der Vicinalflächen. Bei der Krystallisation orientiren sich die Molekeln auf den Flächen des Krystalles ganz gleichförmig durch den Einfluss der Richtkraft der Krystallisation.

“ Jedoch müssen sich diese Kräfte unbedingt mit den Kräften, durch welche die Molekeln von den Concentrationsströmungen fortgezogen werden, zu einer Kraft zusammensetzen. Die sich ablagernden Molekeln orientiren sich nach den Richtungen, die den resultirenden Kräften entsprechen, und am Ende erhält man Flächentheile, welche um einen mehr oder weniger kleinen Winkel aus ihrer normalen Lage gebracht worden sind. Dieses sind die Vicinalflächen. Es ist klar, dass die Lage solcher Vicinalflächen von folgenden Factoren abhängt: (1) Von der Intensität der Strömungen; (2) von der Richtung der Strömung in Bezug auf die normale Lage der Fläche, und (3) von der Form der Fläche, welche selbstverständlich in einem mehr oder weniger directen Zusammenhange mit der Symmetrie des Krystalles steht. Späterhin werden wir sehen, dass die Energie des Wachsthums der Fläche, bis auf einen gewissen Factor genau, der sich in nicht weiten Grenzen ändert, umgekehrt proportional zur reticulären Dichte der Fläche des Krystalles steht. Bei sehr geringer reticulärer Dichte, wie sie sich für die Vicinalflächen ergibt, wenn man ihre Symbole nach den beobachteten Winkeln berechnet, wird diese Energie so gross, dass eine solche Fläche verwächst und verschwindet. Deswegen darf man die Vicinalflächen nicht als Flächen mit complicirten Symbolen betrachten, wie es sehr viele Krystallographen zu thun pflegen.

“ Ebenso wenig darf man die Vicinalflächen als Flächen mit einfachen Symbolen

* “ Studien über relative Wachsthumsgeschwindigkeit der Krystallflächen,” *ibidem*, p. 531.

auffassen, welche aber, nach der Terminologie JEROFEJEW'S, zu verschiedenen 'zusammengehäuften' Individuen gehören, und zwar deswegen, weil die Winkel dieser Flächen nicht genau den idealen Grössen, welche die Symmetrie erfordert, entsprechen. Diese Ansicht ist das Resultat eines falschen Begriffes vom Krystalle als von einem Individuum, das sich unbedingt durch einen bestimmten Anfangspunkt des Wachstums auszeichnet. Wir können den Krystall nur dann als aus mehreren Individuen bestehend betrachten, wenn man in ihm mehrere solche Punkte nachweisen kann. Andererseits erhält man den Begriff 'Zusammenhäufungen der Individuen' in Folge einer einseitigen Vorstellung vom Krystalle, wenn man ihn nur als geometrischen Körper betrachtet. Beide Ansichten über die Vicinalflächen haben nur dadurch entstehen können, dass man den Krystall an und für sich, unabhängig von dem Medium, in welchem er sich bildet, betrachtete."

Now the question whether the vicinal faces are due to the concentration streams is one in which direct appeal can be made to experiment. I have mentioned above the experiments which I made in 1894 with the object of eliminating possible differences of concentration in the mother-liquor. Small crystals of potassium-alum were suspended from the arms of a wooden vane, which was kept rotating in a concentrated solution of the salt for several hours by means of clockwork. No effect whatever seemed to be produced upon the crystals either as regards the presence or absence of vicinal faces or the brilliancy and smoothness of the crystals.

Recently I have made similar, but more precise, experiments in order to ascertain whether the stillness or violent motion of the liquid have any effect in altering the angles of the vicinal forms.

The experiments were made in two ways: a crystal, having been mounted in the platinum clip, was allowed to grow until well developed, and was measured in the solution; without being withdrawn from the solution, it was then attached to a vertical spindle and kept rotating for several hours by means of a small water-motor, and was then measured again. In other experiments the trough of liquid was placed upon a turn-table and set rotating, the crystal remaining fixed within it.

Experiments upon Potassium-alum Crystallising in an Agitated Solution.

An octahedron yielded three well defined vicinal planes upon each of two octahedron faces A and B: the angle between one facet α and the edge of the other facets, β , γ , was measured as in fig. 10.

$$A_{\alpha} : A_{\beta\gamma} = 0^{\circ} 30'; \quad B_{\alpha} : B_{\beta\gamma} = 0^{\circ} 31'.$$

At 4 P.M. the crystal was set rotating, the temperature being 19° C.

At 7.30 P.M., $t = 11^{\circ}$, the crystal was stopped and measured, and gave

$$A_{\alpha} : A_{\beta\gamma} = 0^{\circ} 48'; \quad B_{\alpha} : B_{\beta\gamma} = 0^{\circ} 31';$$

but these were now accompanied by other and less distinct images.

The crystal was re-immersed at 7.45 P.M., and allowed to rotate during the whole night.

Next morning at 9.30 A.M., $t = 11^\circ$, it was measured again and gave upon another octahedron face

$$C_\alpha : C_{\beta\gamma} = 0^\circ 37\frac{1}{2}'$$

these readings being again very good.

The same crystal was re-immersed at 3.30 P.M., $t = 17^\circ$, and the trough was set rotating.

At 9.0 P.M., $t = 10\frac{1}{2}^\circ$, it gave

$$C_\alpha : C_{\beta\gamma} = 0^\circ 39\frac{1}{2}'$$

the readings being very good.

The corresponding readings for the other vicinal forms were:—

	Before rotation.	After rotation.
On A	$0^\circ 32'$	$0^\circ 33\frac{1}{2}'$
„ B	$0^\circ 31\frac{1}{2}'$	$0^\circ 31'$
„ D	$0^\circ 33'$	$0^\circ 29'$

As a result of these experiments it may be asserted that, in alum at any rate, the vicinal faces are neither produced nor appreciably affected by the concentration streams in the solution.

The vicinal faces may, however, vary with the average concentration of the solution in their neighbourhood, or—what may amount to the same thing—with their rate of growth. In fact, it is difficult to think of any other nearly constant, but slightly variable, condition to which they may reasonably be attributed. In any case, the fact to which I wish to draw attention is that the faces which actually occur upon a crystal are not those with simple indices and great reticular density, but those with complex indices and low reticular density.

The faces of alum whose angles were measured by BRAUNS, and whose rate of growth was measured by WEYBERG, were, therefore, not octahedron faces at all, but vicinal faces, and in the arguments relating to them we are not at liberty to assume that they are faces of high reticular density.

Whatever structures may be necessary to account for other features of crystals, there is little doubt that we are justified in regarding their faces as the planes of a space-lattice. Now there is one remarkable property of the space-lattice which bears closely upon the present problem. In general, two planes of the lattice which are nearly coincident in direction are by no means alike in other respects. In the cubic lattice, for example, the cube face is the most dense, and the faces which approximate most closely to it in density are not the planes which most nearly coincide with it

but the dodecahedron and octahedron. To replace the cube or the octahedron by vicinal planes nearly coincident with them is to replace planes of the greatest possible reticular density by planes of the least possible reticular density. And yet the crystal is bounded by the latter rather than by the former. Is it not possible that the supersaturated liquid in immediate contact with the growing alum crystal consists of particles of alum uniformly mingled with particles of water, and that the act of crystallisation consists in the escape of the water, and consequent solidification of the alum? Immediately before the act of crystallisation the alum particles in the solution cannot be so closely packed as those in the crystal, since they are separated by particles of water; if, then, they are to be laid down in plane layers, and are yet to find their places at once as constituent parts of the crystal structure, they will be laid down not along planes of great reticular density but along vicinal planes.

Fig. 21 gives a crude representation* of a cubic structure in which the particles are so widely spaced immediately before the act of crystallisation that they solidify

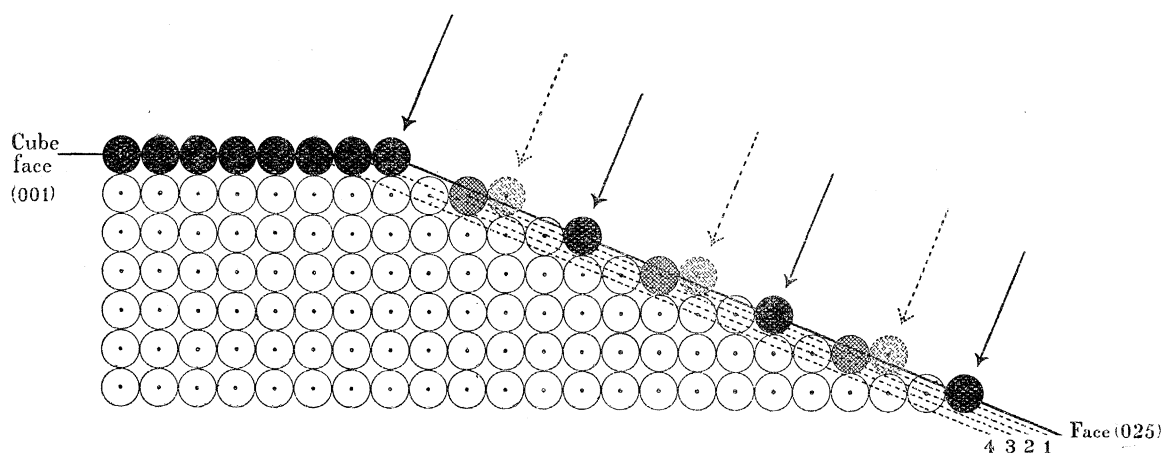

Fig. 21.

along the plane (025). The density in the cube face is 5.385 times as great as the density in this plane; for in the cube plane the mesh is a square (side = a), and in the plane (025) the mesh is a rectangle whose sides are a and $5.385a$ respectively.

It is, of course, impossible from the constitution of a single layer of particles to deduce that of the solution in the neighbourhood of the crystal as a whole; and the refractive index presumably only gives the average constitution of a certain layer of the solution, thin though that layer may be. Nevertheless, the figure indicates that, if the crystallising particles be regarded as a shower falling normally upon the surface, the shower is so dense upon a growing cube face that it would leave little space for the escape of the solvent, whereas upon the face (025), although equally dense as measured along lines perpendicular to the plane of the diagram, it is more than five

* The particles are only represented as circles in contact with each other, in order to make the structure more clear.

times more open as measured in the plane of the diagram. [With vicinal faces of the sort actually observed, the difference is, of course, very much greater; for example, a vicinal plane $(0kl)$ in the cubic lattice inclined at $0^\circ 30'$ to the cube face has a rectangular mesh whose sides are a and $114a$ (about), and the density in the cube face is therefore about 114 times that in the vicinal plane.] Although the plane (025) has a comparatively open structure, the successive layers of particles parallel to this plane are far more closely packed than successive cube layers, as is clear from the figure (lines 1, 2, 3, 4). The black circles represent the particles which, at a given moment, bound the crystal; the plane which preceded it is represented by shaded circles whose centres lie on the line 1, and the set of particles in the act of crystallising is represented by dotted circles.

If we are to speculate concerning the arrangement of the material in layers further removed from the surface of the crystal, we may perhaps suppose that along lines normal to the surface (the arrows of fig. 21) the particles are even as closely packed as along an edge of the cube. Each successive layer is then formed as the crystal solidifies by the particles immediately behind those of the newly solidified layer slipping sideways into their places.

Further, in the case contemplated, each dotted circle in the figure may be taken to represent a line of particles perpendicular to the plane of the drawing, which are packed as closely as the particles along a cube edge in the crystal, *i.e.*, as closely as the horizontal lines of particles. The act of crystallisation will then consist in the deposition of such lines all parallel to the cube edge, but so widely spaced as to lie in a vicinal plane $(0kl)$. This corresponds with the fact that the vicinal planes, though they vary in inclination, always belong to well defined zones; in this instance they will lie in the cube zone, and sodium chlorate possibly affords an example of vicinal planes of the sort depicted in fig. 21.

The determinations made above enable us to compare the weight of material contained in a given volume of the crystal with the weight of the same material in the same volume of the solution; that is to say, the density of the substance in the crystal with its density in the immediate neighbourhood of the crystal, ignoring the solvent. Thus for *alum*:—Taking the specific gravity of the crystallised salt to be 1.72, then 100 cub. centims. of the solid will contain 172 grammes of alum; and 100 cub. centims. of a solution containing 9.3 per cent. alum, and of specific gravity 1.048, will contain 9.74 grammes of alum. The density of alum in the crystal is, therefore, about $17\frac{2}{3}$ times that in the adjacent solution.

For *sodium chlorate*:—Specific gravity of the crystallised salt = 2.289; 100 cub. centims. of the solid will contain 228.9 grammes of sodium chlorate; and 100 cub. centims. of a solution containing 47.73 per cent. of the salt will contain 65.27 grammes of sodium chlorate. The density of sodium chlorate in the crystal is, therefore, about $3\frac{1}{2}$ times that in the adjacent solution.

For *sodium nitrate*:—Specific gravity of the crystallised salt = 2.244; 100 cub.

centims. of the solid contain 224·4 grammes of NaNO_3 ; 100 cub. centims. of a 48·8 per cent. solution contain 66·88 grammes NaNO_3 . The density of sodium nitrate in the crystal is, therefore, about $3\frac{1}{3}$ times that in the adjacent solution.

Without knowing something more concerning the nature of the liquid, it is difficult to establish any relation between these numbers and the particular vicinal face produced.

If we assume that not only the particles in the layer of liquid in immediate contact with the face, but also those in consecutive layers for an appreciable distance, have the same arrangement as in the face itself; then, if the consecutive layers in the crystal are separated by a distance D , and if A be the area of the elementary parallelogram in the growing face,

$$AD = \text{constant} = \text{volume of the elementary parallelepiped in the lattice.}$$

And if consecutive layers in the liquid be separated by an interval X , then the volume of the elementary parallelepiped in the liquid is AX .

The ratio of the density of the material in the crystal to that in the liquid is therefore X/D , and in the substances considered above this quantity would be from $17\frac{2}{3}$ to $3\frac{1}{3}$.

If the relative distances be calculated on the assumption that X be, as suggested above, not less than the least distance which separates adjacent particles in the crystal, the numbers obtained for vicinal faces inclined at $30'$ to the octahedron are not identical with these, but are more than five times as great, whether the structure be the cube, the centred cube, or the cube with centred faces; and for vicinal faces inclined at only about $10'$ to the octahedron the disproportion is far greater.

It will be noticed, however, that to assume any uniform distribution of the crystallisable material in the liquid is to endow it with a crystalline structure before it solidifies. There is, perhaps, nothing impossible in the idea that the material may be already arranging itself immediately before the act of crystallisation. (There is, however, no evidence that this is the case.) Under these conditions, the solution could not possess the ordinary properties of a liquid, and, *inter alia*, might be expected to exhibit double refraction; it was with this possibility in view that the strongly birefringent sodium nitrate was chosen above as a substance to be experimented upon, in the hope that evidence of birefringence might be detected in the solution in contact with the growing face; but no such evidence could be found by the method of total reflection within the crystal.

To obtain anything like a correct estimate of the relative sizes of the meshes in the vicinal faces, and therefore of the distance which separates consecutive layers parallel to them, it would be necessary to measure their angles accurately not to minutes, but to seconds. To determine from the constitution or specific gravity of the liquid any relation between the arrangement of the particles in the vicinal face and in the solution, some assumption must be made concerning the successive layers in the latter.

Such speculations are, however, at present beyond the test of experiment, neither is it possible to say what particular vicinal faces correspond to a certain concentration of the solution until more is known concerning the nature of these layers of solution immediately adjacent to the crystal. In particular, it will be necessary to make accurate determinations of the change of volume produced by dissolving the crystals.

It is sufficient to point out that the wider spacing of the material before it solidifies is a reason why the crystallising substance should descend upon the growing crystal in a shower which is not very dense; and this again is a reason why the growth should take place along vicinal planes, and not along planes with simple indices. That the growth does take place along vicinal planes has been abundantly proved, at any rate for alum, in the preceding pages; that the spacing is very much wider in the liquid than in the crystal has been proved by showing that the liquid about to crystallise is scarcely more than saturated.

Very slight variations in the concentration of the solution would probably correspond to considerable differences in the vicinal planes produced.

The observations recorded above raise many interesting questions; but I have thought it better to confine myself in this paper mainly to observed facts, and to reserve further speculation for another occasion, hoping in the meantime that the enquiry into the nature of the liquid in contact with a growing crystal, which is here opened, will be pursued by others in a more systematic and exhaustive manner.

Note.—A brief statement of some of the results recorded in Part I. (pp. 459–492) was published in the Report of the British Association for 1894, p. 654.

In the latter part of the research I have received useful help from my assistant, Mr. RICHARD GRAHAM, by whom many of the observations in Part II. were made.



Henry A. Miers.

Phil. Trans., A, vol. 202, Plate 13.

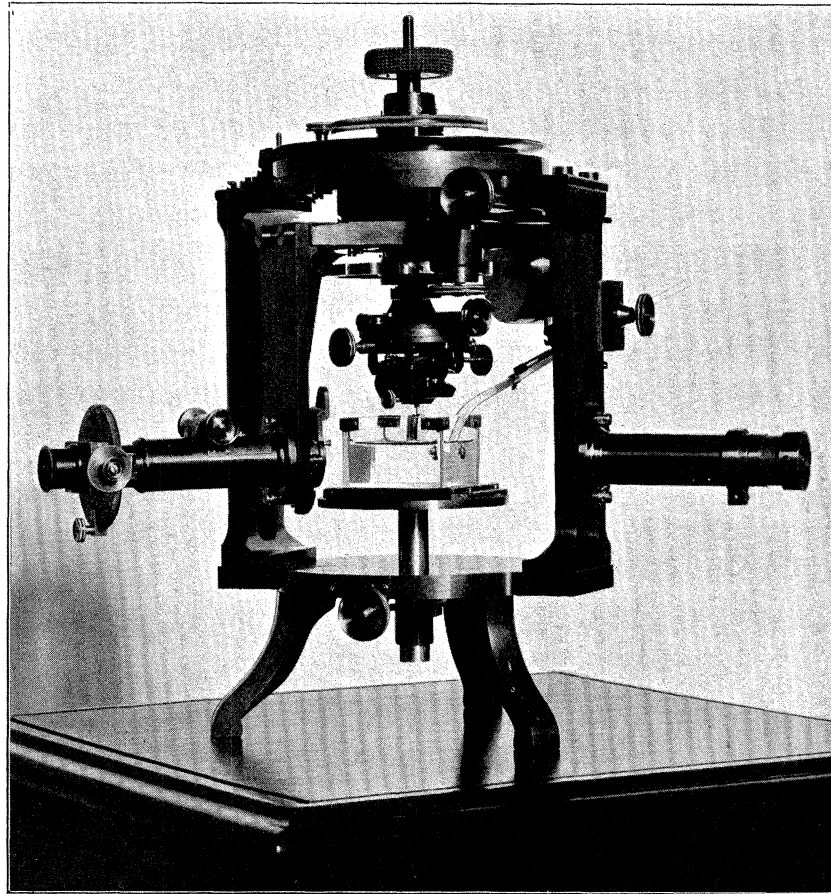

Fig. 1.

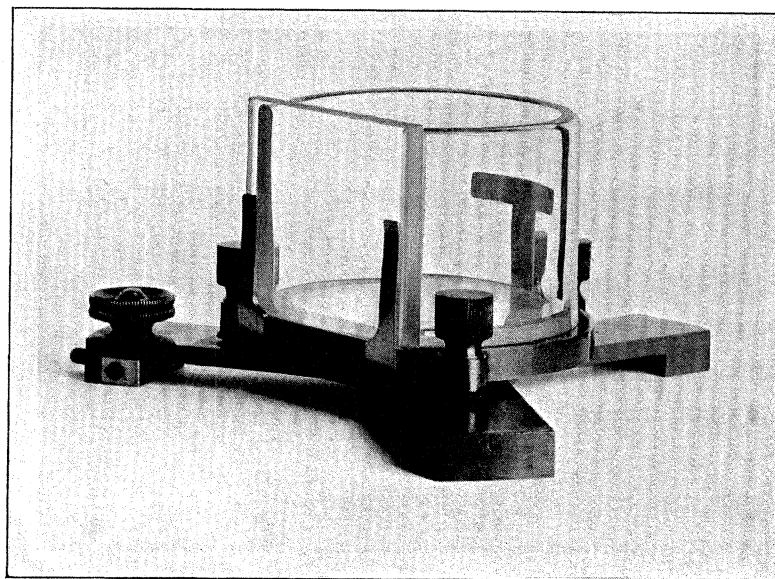
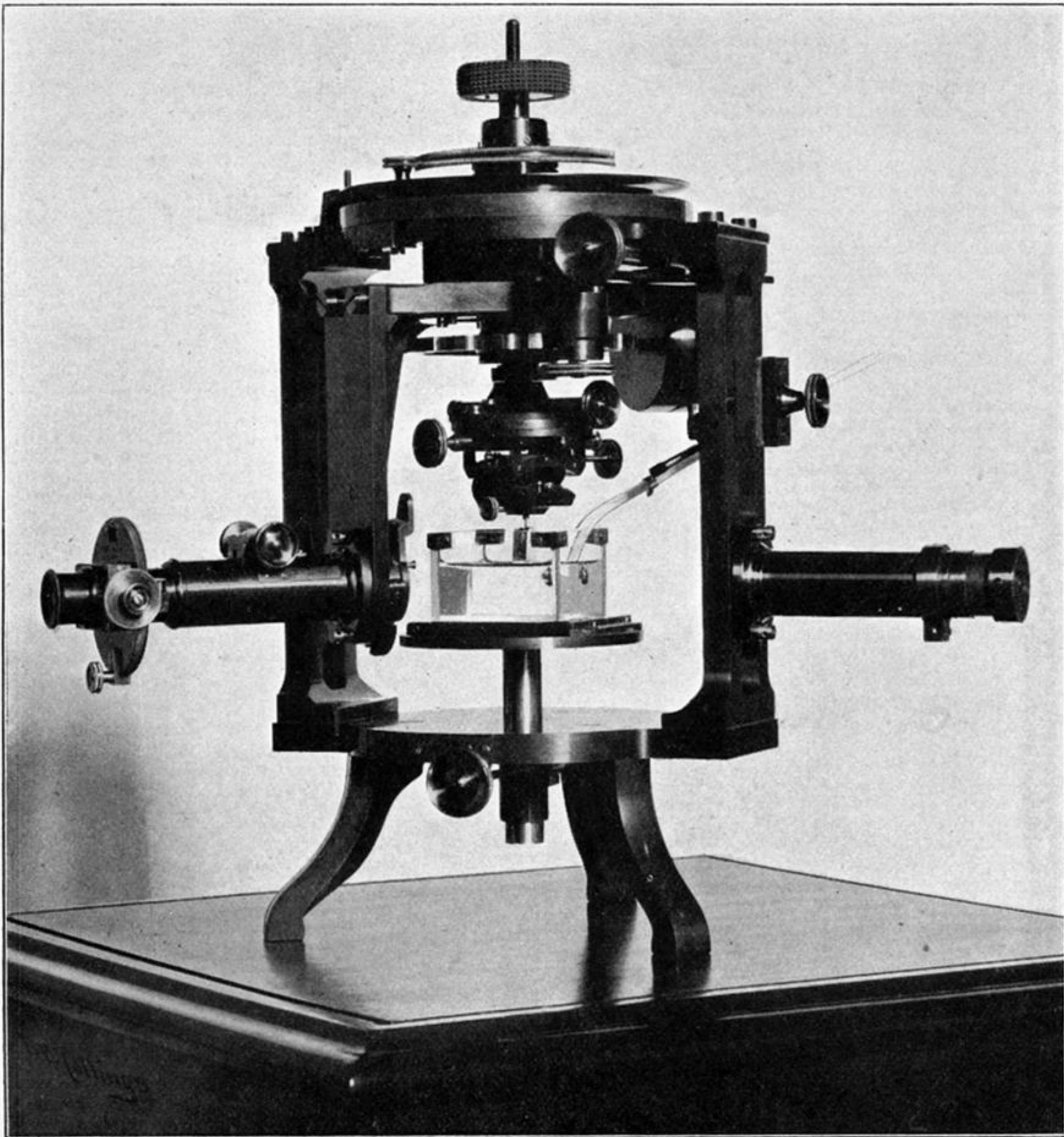

Fig. 16.



Downloaded from rsta.royalsocietypublishing.org

Fig. 1.

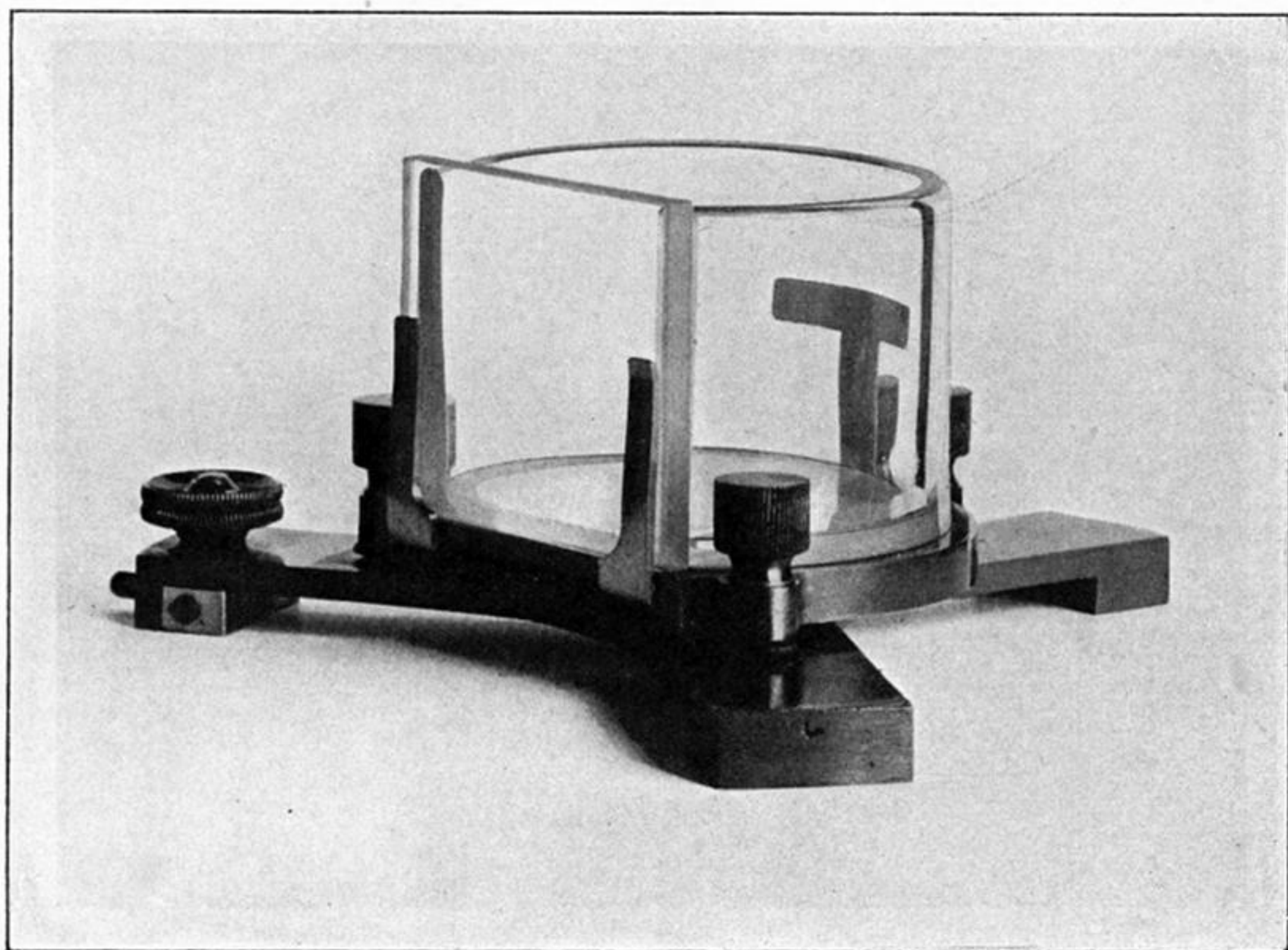

Fig. 16.